

GS 05D01D02-02E

General

Model UT320 Digital Indicating Controller is a highly accurate 1/8 DIN controller, provided with universal input/output. It has a large display for readings and excellent monitoring operability with the Auto/Man switching key. In addition, heating/cooling control, including PID control with auto-tuning, the overshoot suppressing function "SUPER" and the hunting suppressing function "SUPER2" are available as control functions, and a retransmission of variables or a 15V DC loop power supply are also equipped as standard. A communication function or 24V DC loop power supply is available optionally. As described above, the UT320 is a controller provided with higher functions and capability than conventional similar-size controllers.

Main Features

- The latest in large digital displays has been realized and a large PV display with characters 12 mm in height has been employed to be clearly readable from distant locations.
- Universal input and output enable users to set or change freely the type of measured inputs (thermocouple, RTD or DCV), measurement range, type of control output (4 to 20 mA current, voltage pulse, or relay contact), etc. from the front panel.
- Parameters can be easily set using a personal computer. ("Parameter setting tool (model LL100)" sold separately is required.)
- Various communication function are provided. Communication is possible with personal computer, programable logic controller, and other controllers.

Function Specifications

Control Computation Functions

Control computation:

Can be selected from the following types:
Continuous PID control, Time-proportional PID control, Heating/Cooling control (for heating/cooling type only) or Relay ON/OFF control.

Control cycle time: 250 ms

Number of sets of target setpoints and PID parameters: 4

Target setpoint and PID selection:

PID parameters are provided for every target setpoint and the set of PID parameters are selected at the same time that the setpoint number is selected.

Zone PID selection:

PID parameters are selected depending on the value of the PV. For selection, the reference point (PID parameter selection setpoint) or the reference deviation is used.

Reference point method:

The measuring input range is divided into a maximum of three zones with up to two reference points, and PID parameters are selected (No. 1 PID to No. 3 PID) for every zone.

UT320



UT320E

"E" indicates the model with expanded functions.



Reference point = Measuring input range (0%) \cong
Reference point 1 \cong Reference point 2 \cong
Measuring input range (100%)

Reference point hysteresis = Fixed to 0.5% of the measured input range width.

Reference deviation method:

PID parameters (No. 4 PID) are selected when the deviation exceeds the reference deviation. This process takes precedence over the reference point method.

Reference deviation = OFF or 0.1 to 100.0% of measured input range width

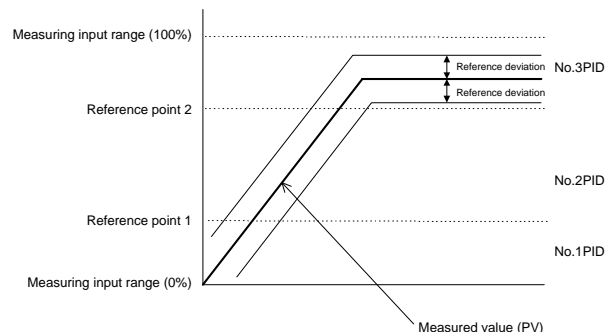

Auto-tuning:

Available as standard. If auto-tuning is operated, PID parameters are automatically set (limit cycle method).

"SUPER" function:

Overshoots generated by abrupt changes in the target setpoint or by disturbances can be suppressed.

"SUPER2" function:

The function stabilizes the state of control that is unstable due to hunting, etc. without requiring any change in PID constants, when the load and/or gain varies greatly, or when there is a difference between the characteristics of temperature zones.

Control Parameters Setting Range

- Proportional band = 0.1 to 999.9%
0.0 to 999.9% (for heating/cooling control,
0.0% for ON/OFF control)
- Integral time = 1 to 6,000 s, or OFF (manual reset)
- Derivative time = 1 to 6,000 s, or OFF
- Manual reset value = -5.0 to 105.0% of output range
(functions when integral time is off.)
- ON/OFF control hysteresis = 0.0 to 100.0% of measured
input range width (0.1 to 0.5% for heating/
cooling control)
- Setpoint rate-of-change setting = off, or 0.0 to 100.0%/h or
min. of measured input range width
A PV tracking function operates automatically
when the setpoint is changed, the power is
turned on, or the mode is changed from
manual to automatic.
- Direct/reverse action:
The output increase/decrease direction can be
defined corresponding to a positive or
negative deviation.
For heating/cooling control, it is fixed; for the
heating side output, reverse, for the cooling
side output, direct.
- Anti-reset windup:
When controller output is limited, normal
integration is superseded by an anti-reset
windup computation to suppress over-
integration.
- Control output cycle time = 1 to 1000 s (for Time-
proportional PID control) and (the cooling
side output cycle time is also the same when
heating/cooling control is used).
- Preset output value = -5.0 to 105.0% of output range
- Output tracking: Whether the output bump is provided or
not can be selected by changing the PID
control mode.
- Output limiter
Upper limit = Lower limit to 105.0% of output
range
Lower limit = -5.0% of output range to upper
limit
- Heating/cooling dead band = -100.0 to 50.0% for output
range

● Signal Computation Functions

- Measured input computation:
Bias addition (-100.0 to 100.0% of measured
input range width), and first-order lag filter
(time constant off or 1 to 120 s)
- Contact input function:
Target setpoint selection, Auto/Man operating
mode switching, key lock parameter display/
non-display switching
Target setpoint selection can be done for
either a 2-setpoint or 4-setpoint selection.
• If the 2-setpoint selection is set, Auto/Man
mode switching can be used as well.
• If the 4-setpoint selection is set, Auto/Man
switching and key lock parameter display/non-
display switching cannot be used together.
If key lock parameter display/non-display
switching is used, target setpoint selection and
Auto/Man mode switching cannot be used.

● Alarm Functions

Eighteen types of alarm functions are provided. The alarm
status is indicated by the alarm lamp on the front panel.
Also, three points among them can be output as relay contact
outputs.

Alarm types:

PV high limit, PV low limit, Deviation high
limit, Deviation low limit, Deenergized on
deviation high limit, Deenergized deviation
low limit, Deviation high and low limits, High
and low limits within deviation, Deenergized
on PV high limit, Deenergized on PV low
limit, SP high limit, SP low limit, Output high
limit, Output low limit, Heater disconnection
alarm, Sensor grounding alarm, FAIL output.

Alarm output:

3 points. Any three points can be output as
contact outputs among the above alarm. For
heating/cooling control, if cooling side output
is output as a relay contact, up to two alarm
outputs can be used.

Setting ranges for PV, deviation, setpoint and output alarms:

PV/setpoint alarm:
-100.0 to 100.0% of measured input range

Deviation alarm:
-100.0 to 100.0% of measured input range
width

Output alarm:
-5.0 to 105.0% of output range

Alarm hysteresis width:
0.0 to 100.0% of measured input range width

Delay timer:

0.00 to 99.59 (minute, second)
An alarm is output when the delay timer
expires after the alarm setpoint is reached.
Setting for each alarm is possible.

Stand-by action:

Stand-by action can be set to make PV/
deviation alarm OFF during start-up or after
SP change until SP reaches the normal region.

Heater disconnection alarm (optional):

two circuits incorporated
A heater disconnection alarm is output if the
heater current consumption is the disconnec-
tion detection value or less. This alarm can be
used for Relay ON/OFF control or time-
proportional PID control.

Heater current setting range: 0.0 to 50.0 A
Setting accuracy: $\pm 5\%$ of span ± 1 digit
Heater current detecting resolution: 0.5 A
Time required until disconnection detection is on: 0.2 s
minimum

Disconnected sensor model: CTL-6-S-H (URD Co. Ltd.)

Sensor grounding alarm:

An alarm is output after detecting a change in
control output. If the moving average * of
control output is out of the setting range
(between the high and low limits of the on/off
rate) in spite of the deviation being within a
fixed range (on/off rate detection width) and
control being in stable condition, the sensor is
judged to be in a grounding condition.

* Moving average refers to the average value for output
values sampled (five times) in every cycle time.

High- and low-limit setting range of on/off rate:

-5.0 to 105.0% of output range

Detection width of on/off rate:

0.0 to 100.0% of measured input range
width.

Fault diagnostic alarm:

Input burnout, A/D conversion error,
thermocouple reference junction compensa-
tion error

FAIL output: Software failure and/or hardware failure
When in Fail, control output, retransmission
output and alarm output become 0% or off.

● **Display and Operation Function**

PV display: In 4-digit digital display for engineering data

Setpoint display:

Various data, such as the setpoint (SP), are displayed by selection on the 4-digit digital display.

Status indicating lamps:

3 alarm indicator lamps: AL1, AL2, AL3

3 setpoint number indicator lamps:

SP2, SP3, SP4 (Go out when SP1 is selected.)

MAN operation mode lamp: MAN (lit in MAN mode)

Operation keys:

△ and ▽ keys:

Increases or decreases setpoints and various parameters.

SET/ENT key:

For data setting or call-up/selection of various parameters

A/M key: Switching of operation mode (Auto/Man)

SELECT display:

A panel where operating parameters that are frequently changed during operation can be selected and registered. For example, by registering the alarm -1 setpoint in the SELECT display, the setpoint can easily be displayed during operation.

Security function:

An operation-inhibiting mode using a password is provided.

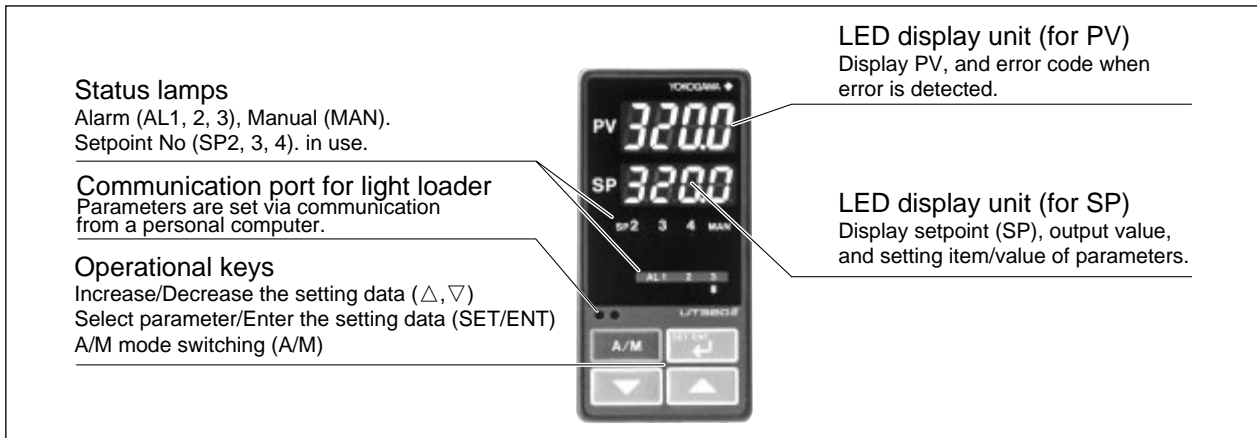

● **Communication Functions (optional)**

This controller has a communication function and can be connected to a personal computer, programmable logic controller, or other /GREEN series controllers.

Communication protocol

Computer link communication:

Communication protocol with a personal computer.

Ladder communication:

Communication protocol with programmable logic controller made.

MODBUS communication:

Communication protocol with a personal computer or PCL.

Coordinated operation:

Communication protocol to coordinate operation with two or more GREEN series controllers. The UT320 can be connected as a master station or a slave station.

Communication interface

Communication protocol:

Computer link, ladder communication, MODBUS communication or coordinated operation

Standards: EIA RS485

Maximum number of connectable controllers:

31 GREEN series controllers

Maximum communication distance: 1,200 m

Communication method:

Two-wire half duplex or four-wire half duplex, start-stop synchronization, non-procedural

Communication rate:

600, 1200, 2400, 4800, 9600 bps

Examples of Communication System Configuration Diagram

(1) Computer link communication/MODBUS communication

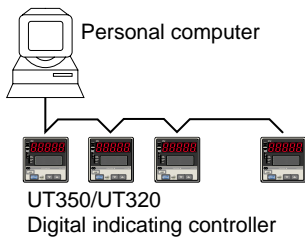

(2) Ladder communication

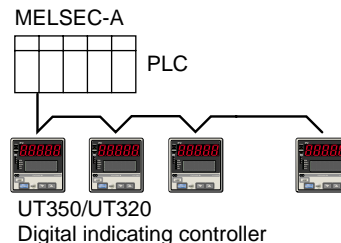

(3) Coordinated operation

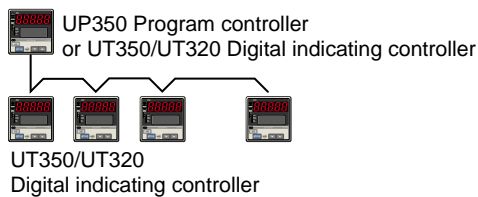

■ Hardware Specifications

Measured Input Signal

Number of input points: 1

Input system:

The types of input/measurement ranges can be set using Key operation or software from a list of inputs.

Input type, measurement ranges and measurement

accuracy:

Refer to the table below.

Input Type	Input range code	Instrument range (°C)	Instrument range (°F)	Measurement accuracy*1	
Unspecified(when shipped from the factory)		Set the data item PV input Type"IN" to the OFF option to leave the PV input type undefined.			
Thermocouple	K	1	-200 to 1370°C	±0.1% of instrument range ±1 digit for temperatures equal to or higher than 0 °C, ±0.2% of instrument range ±1 digit for temperatures below 0 °C	
		2	-199.9 to 999.9°C		0 to 2300°F
		3	-199.9 to 500.0°C		-199.9 to 999.9°F
	J	4	-199.9 to 999.9°C		-300 to 2300°F
	T	5	-199.9 to 400.0°C		-300 to 750°F
		6	0.0 to 400.0°C		-199.9 to 750.0°F
	B	7	0 to 1800°C	32 to 3300°F	±0.15% of instrument range ±1 digit for temperatures equal to or higher than 400 °C ±5% of instrument range ±1 digit for temperatures below 400 °C
	S	8	0 to 1700°C	32 to 3100°F	±0.15% of instrument range ±1 digit
	R	9	0 to 1700°C	32 to 3100°F	
	N	10	-200 to 1300°C	-300 to 2400°F	±0.1% of instrument range ±1 digit ±0.25% of instrument range ±1 digit for temperature below 0 °C
	E	11	-199.9 to 999.9°C	-300 to 1800°F	±0.1% of instrument range ±1 digit for temperatures equal to or higher than 0°C
	L (DIN)	12	-199.9 to 900.0°C	-300 to 1300°F	
	U (DIN)	13	-199.9 to 400.0°C	-300 to 750°F	±0.2% of instrument range ±1 digit for temperatures below 0°C
		14	0.0 to 400.0°C	-199.9 to 750.0°F	
W (DIN)	15	0 to 2300°C	32 to 4200°F	±0.2% of instrument range ±1 digit	
Platinel 2	16	0 to 1390°C	32 to 2500°F	±0.1% of instrument range ±1 digit	
PR20-40	17	0 to 1900°C	32 to 3400°F	±0.5% of instrument range ±1 digit for temperatures equal to or higher than 800°C No guarantee of accuracy for temperatures below 800°C	
W97Re3-W75Re25	18	0 to 2000°C	32 to 3600°F	±0.2% of instrument range ±1 digit	
RTD	JPt100	30	-199.9 to 500.0°C	-199.9 to 999.9°F	±0.1% of instrument range ±1 digit (Note 1) (Note 2)
		31	-150.0 to 150.0°C	-199.9 to 300.0°F	±0.2% of instrument range ±1 digit (Note 1)
	Pt100	35	-199.9 to 850.0°C	-300 to 1560°F	±0.1% of instrument range ±1 digit (Note 1)
		36	-199.9 to 500.0°C	-199.9 to 999.9°F	(Note 2)
		37	-150.0 to 150.0°C	-199.9 to 300.0°F	±0.2% of instrument range ±1 digit (Note 1)
Standard signal	0.4 to 2V	40	0.400 to 2.000	Scaling is enable in the following 4 range. -1999 to 9999 -199.9 to 999.9 -19.99 to 99.99 -1.999 to 9.999	±0.1% of instrument range ±1 digit The read-out range can be scaled between -1999 and 9999.
	1 to 5V	41	1.000 to 5.000		
DC voltage	0 to 2V	50	0.000 to 2.000		
	0 to 10V	51	0.00 to 10.00		
	-10 to 20mV	55	-10.00 to 20.00		
	0 to 100mV	56	0.0 to 100.0		

*1: Performance in the standard operating condition (at 23°C ±2°C, 55±10%RH, and 50/60Hz power frequency)

Note 1: The accuracy is ±0.3°C of instrument range ±1 digit for a temperature range from 0 to 100°C.

Note 2: The accuracy is ±0.5°C of instrument range ±1 digit for an temperature range from -100 to 0°C and 100 to 200°C.

Sampling period: 250 ms

Burnout detection:

Functions with a thermocouple (TC), RTD, standard signal 0.4 to 2 V DC, and 1 to 5 V DC.

Can be specified as upscale, downscale, and off. For standard signal, judged as burnout at 0.1 V or less.

Input bias current: 0.05 µA (for TC/RTD b-terminal)

Measuring current(RTD): about 0.13mA

Input resistance:

1 MΩ or more for TC/mV input
About 1 MΩ for DC voltage input

Allowable signal source resistance:

250 Ω or less; effect of permissible signal source resistance 0.1 µV/Ω or less for TC/mV input

2 kΩ or less; effect of permissible signal source resistance 0.01%/100 Ω or less for DC voltage input

Allowable leadwire resistance:

Max. of 150 Ω/wire (resistance in each of three wires must be equal) for RTD input
However, 10 Ω/wire for a maximum range of -150.0 to 150.0°C.

Effect of permissible leadwire resistance ±0.1°C/10Ω or less

Allowable input voltage:
 ±10 V DC for TC/mV/RTD input
 ±20 V DC for DC voltage input

Noise rejection ratio:
 Normal mode 40 dB (50/60 Hz) or more
 Common mode 120 dB (50/60 Hz) or more

Reference-junction compensation error:
 ±1.0°C (15 to 35°C),
 ±1.5°C (0 to 15°C, 35 to 50°C)

Applicable standards: JIS, IEC, or DIN (ITS-90) for TC and RTD

24V DC Loop Power Supply for Sensor

The controller supplies power to a two-wire transmitter. Place a resistor (10 to 250Ω) between the controller and the transmitter, convert a current signal to a voltage signal, and read it from the PV input.

21.6 to 28.0V DC, maximum supply current is about 30mA (only for models with 24V DC loop power supply).

Ambient temperature should be 0 to 40°C when using 24V DC loop power supply for UT320.

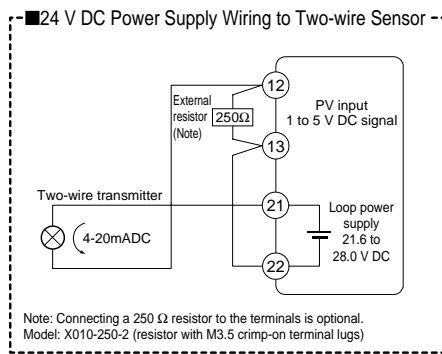

Retransmission Output

Either PV, target setpoint, or control output is output. Either the retransmission output or the 15V DC loop power supply can be used.

Number of output points: 1
 Output signal: 4 to 20 mA DC
 Load resistance: 600 Ω or less
 Output accuracy: ±0.3% of span
 * Performance in the standard operating conditions (at 23± 2°C, 55± 10% RH, and 50/60 Hz power frequency)

15V DC loop power supply:

Supply voltage is 14.5 to 18.0 V DC. Maximum supply current is about 21 mA (with a protection circuit for a field short-circuit).

Control Outputs

The control output is of a universal scheme and can be selected from the following types of outputs. In the case of heating/cooling control, it is also selectable from these outputs. However, if the cooling side output is a relay contact output, the alarm-3 cannot be used, and similarly if the cooling side output is a voltage pulse or current output, the retransmission output/15V DC sensor power supply cannot be used.

Current output
 Number of output points: 1 or 2 (2 for heating/cooling),
 Switched between voltage pulse output and current output.
 Output signal: 4 to 20 mA
 Load resistance: 600 Ω or less

Output accuracy: ±0.3% of span
 Performance in the standard operating conditions (at 23± 2°C, 55± 10% RH, and 50/60 Hz power frequency)

Voltage pulse output
 Number of output points: 1 or 2 (2 for heating/cooling type),
 Switched between voltage pulse output and current output.

Output signal:
 On voltage = 12 V DC or more (load resistance of 600Ω or more; current on short-circuiting about 30 mA)
 Off voltage = 0.1 V DC or less

Resolution: 10 ms

Relay contact output
 Number of output points: 1 or 2 (2 for heating/cooling type)
 Output signal:
 Three terminals for NC, NO, and Common transfer-contact

Contact rating:
 250 V AC, 3 A or 30 V DC, 3 A (resistive load)
 Resolution: 10 ms

Contact Inputs

Usage:
 Target setpoint selection, Auto/Man mode switching, or Key lock parameter display/non-display switching

Number of input points: 2
 Input type: Non-voltage contact input or transistor open collector input
 Input contact rating: 12 V DC, 10 mA or more (for non-voltage contact input)

On/off determination:
 For non-voltage contact input,
 ON= contact resistance of 1 kΩ or less,
 OFF= contact resistance of 20 kΩ or more.
 For transistor contact input,
 ON= 2 V or less,
 OFF= leakage current of 100 μA or less.

Minimum retention time for status detection: About 1 second

Contact Outputs

Usage: Alarm output, FAIL output, and others
 Number of relay contact output points: 3
 Relay contact rating: 240 V AC, 1 A or 30 V DC, 1 A
 (COM terminals is common for every contact output.)

● Display Specifications

PV display: 4-digit, 7-segment red LED; character height - 12 mm
 Setpoint display: 4-digit, 7-segment red LED; character height - 9.3 mm
 Status indicating lamps: LEDs

● Conformance to Safety and EMC Standards

Safety: Compliant with IEC/EN61010-1: 2001, approved by CSA1010, approved by UL508.
 Installation category : CAT. II (IEC/EN61010, CSA1010) Pollution degree : 2 (IEC/EN61010, CSA1010)
 Measurement category : I (CAT. I : IEC/EN61010)
 Rated measurement input voltage : 10V DC max.(across terminals), 300V AC max.(across ground)
 Rated transient overvoltage : 1500V (Note)

Note : It is a value on the safety standard which is assumed by IEC/EN61010-1 in measurement category I, and is not the value which guarantees an apparatus performance.

EMC standards:Complies with EN61326

During test, the controller continues to operate with the measurement accuracy within $\pm 20\%$ of the range.

● Construction, Mounting, and Wiring

Construction: Dust-proof and Drip-proof front panel conforming to IP55.

For side-by-side close installation, controller loses its dust-proof and drip-proof protection.

Material: ABS resin and polycarbonate

Case color: Black

Weight: Approx. 1 kg or less

External dimensions:

48 (width) \times 96 (height) \times 100 (depth) mm

Mounting: Direct panel mounting; mounting bracket, one each for upper and lower mounting

Panel cutout dimensions: $45^{+0.6}_0$ (width) \times $92^{+0.8}_0$ (height) mm

Mounting attitude:

Up to 30 degrees above the horizontal. No downward tilting allowed.

Wiring: M3.5 (ISO 3.5 mm) screw terminals (signal wiring and power/ground wiring as well)

● Power Supply Specifications and Isolation

Power supply: Rated at 100 to 240 V AC ($\pm 10\%$), 50/60 Hz

Power consumption: MAX. 20 VA (MAX. 8.0W)

Internal fuse rating: 250 VAC, 16.A time-lug fuse

Memory back-up: Non-volatile memory (Service life approx. 1,000,000 times of writings)

Withstanding voltage:

1500 V AC for 1 minute between primary and secondary terminals

1500 V AC for 1 minute between primary and ground terminals

1500 V AC for 1 minute between ground and secondary terminals.

500V AC for 1minute between two secondary terminals

(Primary terminals = Power and relay output terminals)
 (Secondary terminals = Analog I/O signal terminals, voltage pulse output terminals, contact input terminals)

Isolation resistance:

20 M Ω or more when 500 V DC voltage is applied between the power terminals and ground terminal.

Grounding:

Class D grounding (grounding resistance of 100 Ω or less)

● Isolation specifications

Measured input terminal:

Isolated from other I/O terminals. Not isolated from internal circuits.

15 V DC loop power supply terminals:

Not isolated from 4-20mA analog output and voltage pulse control output. Isolated from other I/O terminals and internal circuit.

24V DC loop power supply terminals:

Isolated from other I/O terminals and internal circuit.

Control output (current or voltage pulse) and retransmission terminals:

Not isolated between control output terminals and retransmission output terminal. Isolated from other I/O terminals and internal circuits.

Relay contact control output terminals:

Isolated from other I/O terminals and internal circuits.

Contact input terminals:

Not isolated from other contact input terminals mutually, and communication terminals. Isolated from other I/O terminals and internal circuits.

Relay contact alarm output terminals:

Isolated from other I/O terminals and internal circuits.

RS-485 communication terminals:

Not isolated from contact input terminals. Isolated from other I/O terminals and internal circuits.

Power terminals:

Isolated from other I/O terminals, ground terminal, and internal circuits.

Ground terminal:

Isolated from other I/O terminals, power terminals, and internal circuits.

● Environmental Conditions

Normal operating conditions:

Ambient temperature: 0 to 50°C (40°C or less for mounting of instruments side-by-side)

The operating ambient temperature range is between 0°C and 40°C when the 24VDC loop power supply.

Ambient temperature change limit:10°C/h or less

Ambient humidity: 20 to 90% RH (no condensing)

Magnetic field: 400 A/m or less

Continuous vibration (5 to 14 Hz):

Peak-to-peak amplitude of 1.2 mm or less

Continuous vibration (14 to 150 Hz):

4.9 m/s² or less

Short-period vibration: 14.7 m/s² or less, 15 s

Shock: 147 m/s² or less, 11 ms

Installation altitude : 2,000 m or less above sea level

Warm-up time 30 minutes or more

Transportation and storage conditions:

Temperature: -25 to 70°C

Temperature change limit:20°C/h or less

Humidity: 5 to 95% RH

Effect of operating conditions

Effect of ambient temperature:

For voltage or TC inputs:

Whichever is greater, $\pm 1 \mu\text{V}/^\circ\text{C}$ or $\pm 0.01\%$ of F.S./ $^\circ\text{C}$

For RTD inputs:

$\pm 0.05^\circ\text{C}/^\circ\text{C}$ (ambient temperature) or less for RTD input

$\pm 0.05\%$ of F.S./ $^\circ\text{C}$

For analog output:

$\pm 0.05\%$ of F.S./ $^\circ\text{C}$ or less

Effect of power supply fluctuation (within rated voltage range):

For analog input:

Equal to or less than whichever is greater, $\pm 1 \mu\text{V}/10 \text{ V}$ or

$\pm 0.01\%$ of F.S./10 V

For analog output: $\pm 0.05\%$ of F.S./10 V or less

Function Block Diagram for Standard Type

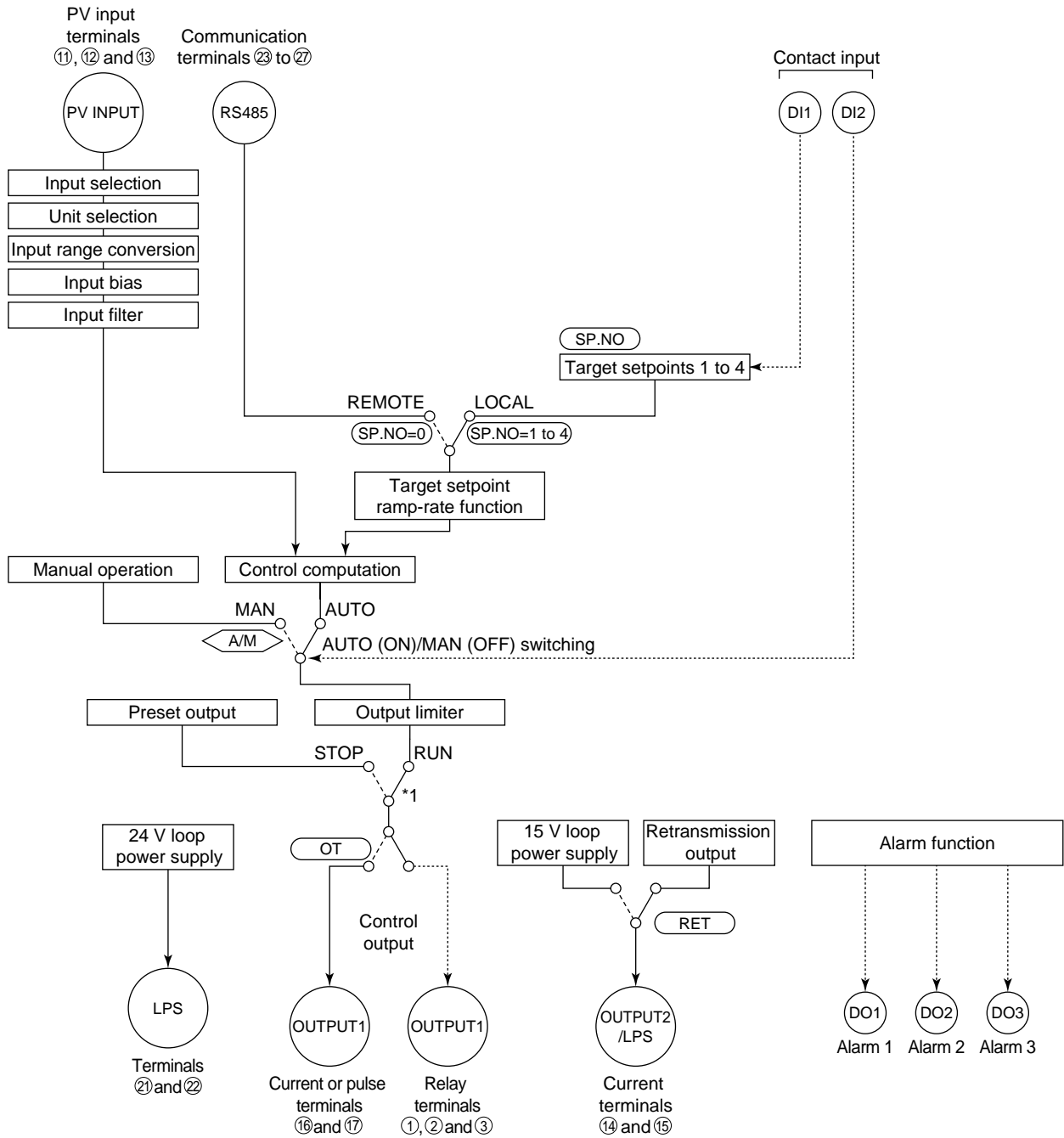

*1: If the setup parameter DIS (DI function selection) is set to "4", when the contact input 2 is ON (run state), that controller outputs the preset output value.

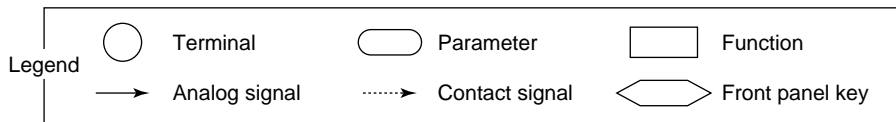

Function Block Diagram for Heating/Cooling Type

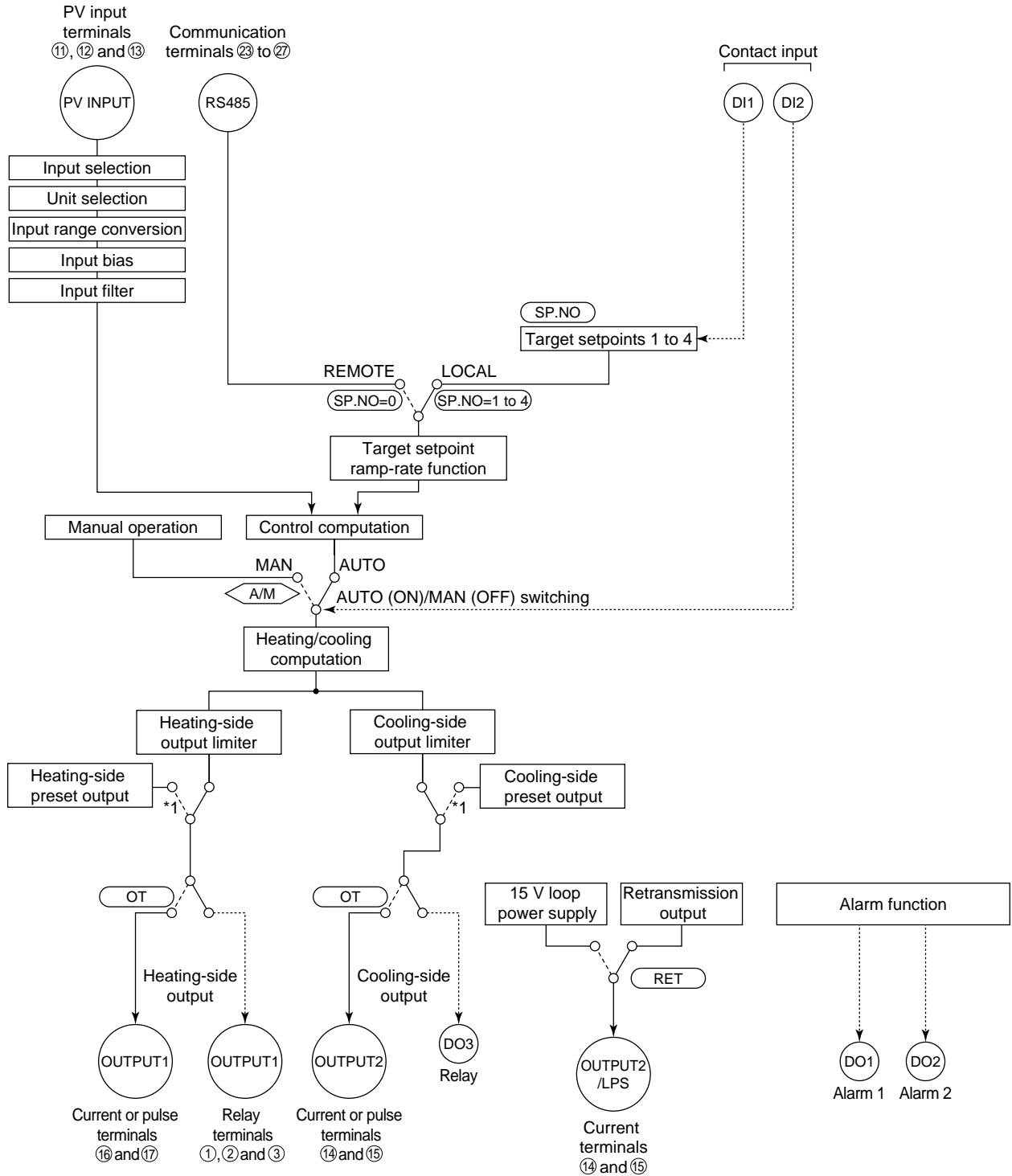

*1: If the setup parameter DIS (DI function selection) is set to "4", when the contact input 2 is ON (run state), that controller outputs the preset output value.

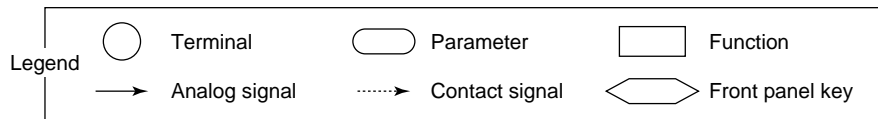

Standard Type, Terminal Arrangements

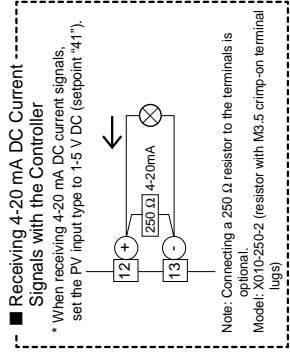

PV input * Not configured at factory before shipment
See "2. Initial Settings," for more information.

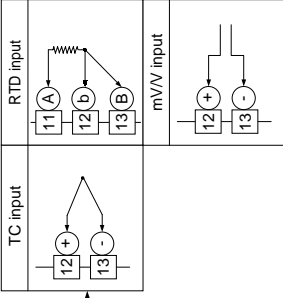

* Wiring can only be carried out for controllers with 24 V DC loop power supply.

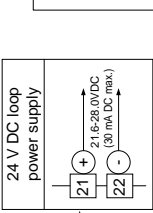

* Wiring can only be carried out for controllers with communication functions. Maximum baud rate: 9600 bps

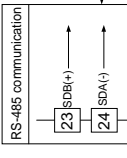

Control output
Relay contact output
NC NO COM
Contact rating: 250 V AC, 3 A
30 V DC, 3 A (resistance load)

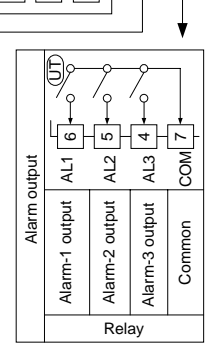
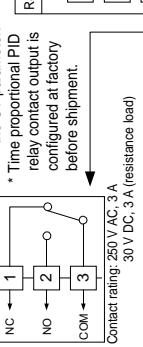

Power supply
Power supply
L N
Allowable range: 100 to 240 V AC (±10%)
(free voltage)
50/60 Hz shared

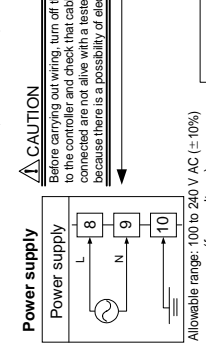

Control output
Current/voltage pulse output
16 17
4-20 mA DC voltage pulse (12 V)

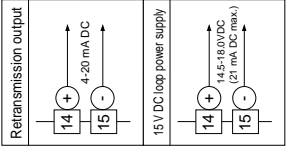
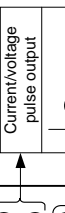

* PV retransmission is configured at factory before shipment.

Load resistance: 600 Ω or less

* If 15 V DC loop power supply is used, retransmission output cannot be used.

* DIS is a setup parameter.
Changing DIS setpoint allows you to change the function of external contact input.

Correspondence between parameter DIS and external contact input functions	
When DIS=1 (Factory-shipped setting)	When DIS=2
No function	Hides the LOCK parameter when D11=ON, Shows the LOCK parameter when D11=OFF.
No function	No function
Common	Common
When DIS=3	When DIS=4
When switching target is SP, 1.SP, 2.SP, 3.SP, 4.SP, 5.SP, 6.SP, 7.SP, 8.SP, 9.SP, 10.SP, 11.SP, 12.SP, 13.SP, 14.SP, 15.SP, 16.SP, 17.SP, 18.SP, 19.SP, 20.SP, 21.SP, 22.SP, 23.SP, 24.SP, 25.SP, 26.SP, 27.SP, 28.SP, 29.SP, 30.SP	When D11=ON 2.SP when D11=ON, 1.SP when D11=OFF. When D12=ON 1.RUN when D12=ON, 2.STOP when D12=ON, 3.COM when D12=OFF.
Common	Common

* This wiring is only possible for a controller with a heater burnout alarm.

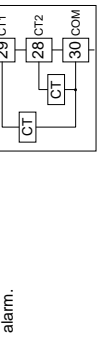

* OT is a setup parameter. You can change the settings of the parameter OT to change the control output type.
See "2. Initial Settings," for more information.

Correspondence between parameter OT and control output types	
OT=0 (factory-shipped setting)	OT=1
Time proportional control Relay output (terminals ①, ② and ③)	Time proportional control Voltage pulse output (terminals ⑥ and ⑦)
OT=2	OT=3
Current output (terminals ⑧ and ⑩)	On-off control Relay output (terminals ①, ② and ③)

Note: External Contact Input
If the power is turned on when the external contact input is OFF, the mode (SP, NO or AIM) existing before the power is turned off will be continued. (except for RUN/STOP)

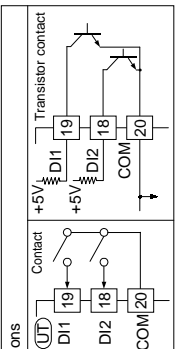

Heating/Cooling, Terminal Arrangements

Heating-side control output

Time proportional PID relay contact output is configured at factory before shipment.
 * Available if 4, 7, or 10 is set in the OT (Control Output Type) setup parameter.

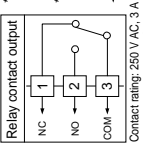

RS-485 communication
 23 (SDA+) 24 (SDA-) 25 (RDB+) 26 (RDB-) 27 (SG)

TC input
 11 (A) 12 (b) 13 (B)

RTD input
 11 (A) 12 (b) 13 (B)

mV/V input
 12 (+) 13 (-)

PV input * Not configured at factory before shipment for controllers with communication functions.
 Maximum baud rate: 9600 bps

Receiving 4-20 mA DC Current Signals with the Controller
 * When receiving 4-20 mA DC current signals, set the PV input type to 1-3 V DC (setpoint 41').

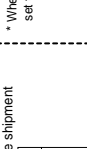

Alarm output/cooling-side control output

Note: The cooling-side control output is selected if 4, 5 or 6 is set in the OT (Control Output Type) setup parameter. The alarm-3 output is not available. The controller is factory-set to the cooling-side control output (time proportional PID relay contact output).



Relay contact rating: 240 V AC, 1 A
 30 V DC, 1 A (resistance load)

Heating-side control output
 Current/voltage pulse output
 16 (+) 17 (-)
 4-20 mA DC, voltage pulse (12 V)

Retransmission output
 14 (+) 15 (-)
 4-20 mA DC

Cooling-side control output
 14 (+) 15 (-)
 4-20 mA DC, voltage pulse (12 V)

15 V DC loop power supply
 14 (+) 15 (-)
 4.5±0.07VDC, 21 mA DC(max)

15 V DC loop power supply is used, retransmission output cannot be used.
 * The retransmission output and 15 V DC loop power supply are not available if the cooling-side control output is set to "continuous output" and "voltage pulse output."

External Contact Input
 Note: External Contact Input If the power is turned on when the external contact input is OFF, the mode (SP, NC or AM) existing before the power is turned off will be continued. (except for RUN/STOP)

Power supply

Before carrying out wiring, turn off the power to the controller and check that cables to be connected are not alive with a tester or the like because there is a possibility of electric shock.



Heater current detection input
 29 (CT1) 28 (CT2) 30 (COM)

When DIS-1 (Factory-shipped setting)
 2.SP when DI1=ON
 1.SP when DI1=OFF

When DIS-2
 Hides the LOCK parameter when DI1=ON
 Shows the LOCK parameter when DI1=OFF

When DIS-3
 When switching target
 2.SP when DI1=ON
 1.SP when DI1=OFF

When DIS-4
 Transistor contact
 +5V
 +5V
 COM

When DIS-5
 Common

When DIS-6
 Common

Correspondence between parameter OT and heating-side/cooling-side output types

OT	Heating side	Cooling side
OT=4 (factory-shipped setting)	Heating side: Relay output (terminals ① and ②)	Cooling side: Relay output (terminals ① and ②)
OT=5	Heating side: Voltage pulse output (terminals ① and ②)	Cooling side: Relay output (terminals ① and ②)
OT=6	Heating side: Current output (terminals ① and ②)	Cooling side: Voltage pulse output (terminals ① and ②)
OT=7	Heating side: Relay output (terminals ① and ②)	Cooling side: Voltage pulse output (terminals ① and ②)
OT=8	Heating side: Voltage pulse output (terminals ① and ②)	Cooling side: Current output (terminals ① and ②)
OT=9	Heating side: Current output (terminals ① and ②)	Cooling side: Voltage pulse output (terminals ① and ②)
OT=10	Heating side: Relay output (terminals ① and ②)	Cooling side: Current output (terminals ① and ②)
OT=11	Heating side: Voltage pulse output (terminals ① and ②)	Cooling side: Current output (terminals ① and ②)
OT=12	Heating side: Current output (terminals ① and ②)	Cooling side: Voltage pulse output (terminals ① and ②)

The control output types, "relay output" and "voltage pulse output" shown in the table above refer to those of time proportional control. To change the type to a relay output for on-off control, select "Relay" terminals and change the setpoint of the proportional band to "0".

Correspondence between parameter DIS and external contact input functions

When DIS-1	When DIS-2	When DIS-3	When DIS-4	When DIS-5	When DIS-6
2.SP when DI1=ON 1.SP when DI1=OFF	Hides the LOCK parameter when DI1=ON Shows the LOCK parameter when DI1=OFF	When switching target 2.SP when DI1=ON 1.SP when DI1=OFF	Transistor contact +5V +5V COM	Common	Common

* DIS is a setup parameter. Changing DIS setpoint allows you to change the function of external contact input.

* This wiring is only possible for a controller with a heater burnout alarm.

* Wiring can only be carried out for controllers with 24 V DC loop power supply.

* 15 V DC Power Supply Wiring to Two-wire Sensor

* 24 V DC Power Supply Wiring to Two-wire Sensor

* 15 V DC Power Supply Wiring to Two-wire Sensor

* 24 V DC Power Supply Wiring to Two-wire Sensor

Note: Connecting a 250 ohm resistor to the terminals is optional. Model: X010-250-2 (resistor with M3.5 crimp-on terminal lugs)

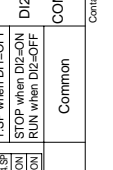
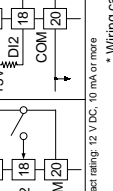
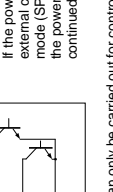
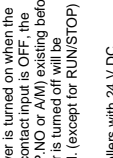

Note: Connecting a 250 ohm resistor to the terminals is optional. Model: X010-250-2 (resistor with M3.5 crimp-on terminal lugs)

Note: Connecting a 100 ohm resistor to the terminals is optional. Model: X010-100-2 (resistor with M3.5 crimp-on terminal lugs)

Note: Connecting a 250 ohm resistor to the terminals is optional. Model: X010-250-2 (resistor with M3.5 crimp-on terminal lugs)

Note: Connecting a 250 ohm resistor to the terminals is optional. Model: X010-250-2 (resistor with M3.5 crimp-on terminal lugs)

External Dimensions and Panel Cutout Dimensions

Unit: mm

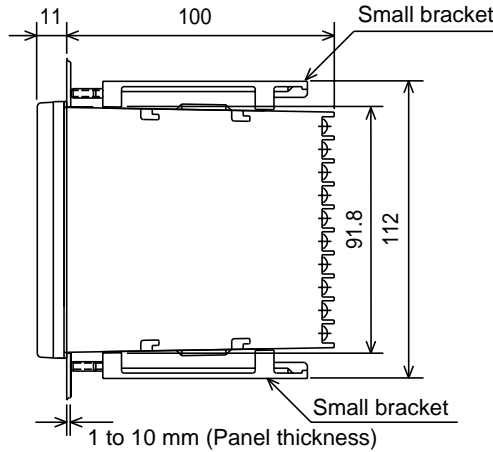
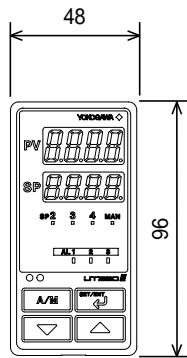

General installation

Side-by-side close installation

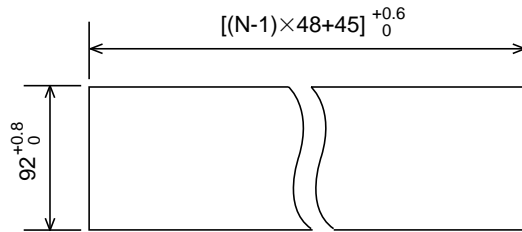
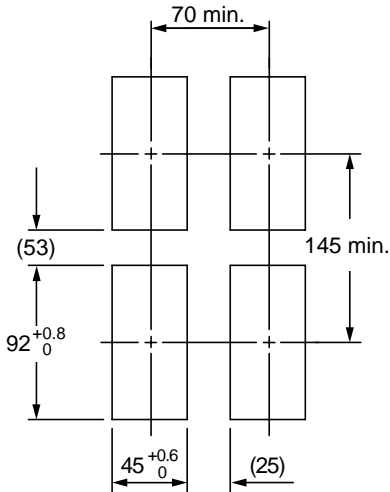

"N" stands for the number of controllers to be installed.
However, the measured value applies if N ≥ 5.

Model and Suffix codes

Model	Suffix Code	Description
UT320		Digital indicating controller (provided with retransmission output and 15 V DC loop power supply as standard)
Type	-0	Standard type
	-2	Heating/cooling type
	-3	Standard type (with 24 V DC loop power supply)
Optional functions	0	None
	1	With communication, heater burnout alarm
	2	With heater burnout alarm

Standard accessories: Brackets (mounting hardware), Unit label, User's manuals, and User's Manual (reference) (CD-ROM version)

Items to be specified when ordering

Model and suffix codes, necessary/unnecessary of User's Manual or QIC.