

General Specifications

Model UP550 Program Controller



GS 05E01C02-01E

General

Model UP550 Program Controller can store up to 30 program patterns, and has a powerful control capability and the user-friendly large numerical display. The UP550 features as standard many functions which are necessary for various control applications, and all of these functions such as program setting function, control function, control computation function, signal computation function, etc. can be configured by using the keys on the front panel. The instrument has five types of control strategies, and also an overshoot suppressing function "SUPER" and a heating suppressing function "SUPER 2" built in as standard, as well as an auto-tuning function.

Main Features

- Extra-large digital display allows the indicated values to be read even from a long distance. LEDs of 20 mm height are used for the process variable display. This is a five-digit display for higher resolution.
- User-friendly, full-dot LCD display, capable of showing not only control setpoints (SPs) and parameters but also program patterns and deviation (DV) trend logs.
- Program setting function with storage capacity for up to 30 program patterns and 300 program segments, allowing the controller to be used for a wide range of heat-treatment applications.
- Five types of control function, including single-loop control, cascade control, loop control with PV auto-selector, enabling the operator to start control operation immediately after simply entering the settings.
- The program pattern-2 retransmission function outputs a program pattern by way of the retransmission output. This function is used in combination with retransmission output setup parameter RET 1 or RET 2, for which program pattern-2 should be selected, and is used for pattern transmission to another instrument (available for UP made 1, 2, 6 or 7).
- Parameters and program patterns can be easily set using a personal computer. ("Parameter setting tool (model LL100)" sold separately is required.)
- Universal input and output enables users to set or change freely the type of measured inputs, measurement input range, type of control output, etc. from the front panel.
- Contact inputs (up to 7 points) and contact outputs (up to 7 points) can be employed and functions can be assigned to each contact (the maximum number of points varies depending on the specification code), with one additional contact input available by specifying the appropriate suffix code. (Contact outputs can be increased up to eight; see "Number of Event/Alarm Outputs" on page 2 or "Contact Outputs" on page 7.)
- Various communication functions are provided. Communication is possible with personal computer, programmable logic controller, and other controllers.

UP550



UP550E
"E" indicates with the model with expanded functions.

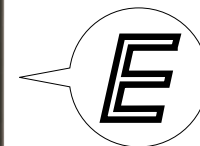

Functional Specifications

Program Setting Function

The program setting function increases or decreases the value of a target setpoint (SP) according to a given program pattern that varies with time. The controller stores two or more program patterns and the operator can switch between them according to the operating status. Each program pattern consists of multiple line segments (program segments). The operator sets the time interval of each program segment using the segment time or slope. The operator can also set such instructions as the number of repeats, start/stop, and status output (event output) for a given program pattern.

- Number of program patterns: 30 maximum
- Number of program segments per pattern: 99 maximum
- Number of program segments: 300 maximum (sum of segments for all program patterns)
- Configurable number of events: 400 maximum (sum of events for all program patterns)
- Number of program repeats: 999 maximum, or unlimited repeats.
- Segment time: 0 minute 0 s to 59 minute 59 s, or 0 h 0 minute to 99 h 59 minute.
- Start/stop of program pattern: Program patterns can be started (RUN), stopped (RESET), paused (hold) or advanced by means of contact inputs or from instrument operation.
- Switching between program patterns: Achieved by contact inputs or from instrument operation.

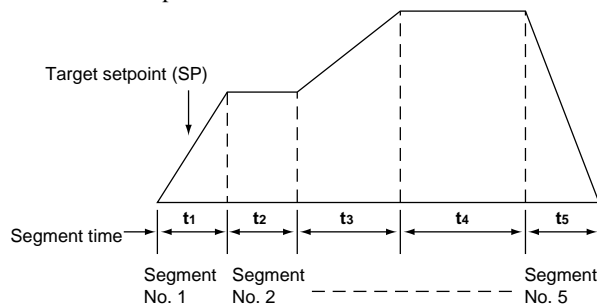

Example of Program Pattern

Wait Function

The wait function delays the execution of a program pattern when a process-variable (PV) input fails to keep track of changes in the given target SP. The wait function has two parameters: a wait zone and a wait time. The wait zone is a margin of deviation that is used to judge how precisely the PV input is tracking. The wait time is the time to wait for a PV input to reach the wait zone. If a PV input reaches the wait zone within the given wait time, the program advances to the next segment. Even if the PV input fails to reach the wait zone within the given wait time, the program also advances to the next segment when the wait time elapses.

Wait time: OFF, or 0 minute 1 s to 99 minute 59 s or
0 h 1 minute to 99 h 59 minute.
Wait zone: 0 to 10% of measured input range width.

UP Modes and Program Setting Function

The UP modes with a single program setting function are: Single-loop control, cascade primary-loop control, loop control with PV switching, loop control with PV auto-selector, and cascade control. Note that, in cascade control, the program setting function acts on the primary-loop only.

Program Setting Function and PID Parameters Switching

The controller can switch between PID parameter sets as a program pattern progresses.

Segment PID selection:

PID-parameter numbers being used can be selected on a segment basis.

Zone PID selection:

PID parameter sets are switched depending on the value of the applied PV input. Either the reference point method (reference point: a setpoint for switching between PID parameter sets) or the reference deviation method is used for the switching.

Reference point method:

Divides the measuring input range into as many as seven zones using a maximum of six reference points, and switching between PID parameter sets is done on a zone basis.

Reference deviation method:

Switches between PID parameter sets depending on whether the control deviation (DV) is within the given reference deviation or exceeding the deviation. This method has priority over the reference point method during operation.

Time Events

The time event function notifies the progress of a program pattern, such as the time when the program moves from one segment to another, by means of an indicator lamp or contact output.

Configurable number of time events: Max.8 points

Time event setpoint:

Allows the controller to output a time event ON or OFF after the lapse of a specific time from when the program switches from one segment to another. The lapse of time is configurable between 0 minute 0 s and 99 h 59 minute.

Number of time event indicator lamps: 4 points (TME 1, 2, 3, 4)

PV Events

The PV event is a PV/DV alarm function defined within a given program pattern.

Configurable number of PV events: 8 points maximum
PV event indicator lamps: 2 points (PVE1 and PVE2)

Event types: PV high limit, PV low limit, Deviation high limit, Deviation low limit, Deenergized on deviation high limit, Deenergized on deviation low limit, Deviation high and low limits, High and low limits within deviation, Deenergized on PV high limit, Deenergized on PV low limit, SP high limit, SP low limit, Output high limit, Output low limit.

Configurable ranges of PV events:

PV alarm: -100 to 100% of measured input range

DV alarm: -100 to 100% of measured input range width

Alarm hysteresis: 0.0 to 100.0% of measured input range width

Instrument Alarm Functions

The instrument alarm function outputs PV, deviation, SP, and other alarm without regards to the program pattern. Controller has four instrument alarm outputs.

Alarm types: PV high limit, PV low limit, Deviation high limit, Deviation low limit, Deenergized on deviation high limit, Deenergized on deviation low limit, Deviation high and low limits, High and low limits within deviation, Deenergized on PV high limit, Deenergized on PV low limit, SP high limit, SP low limit, Output high limit, Output low limit.

Alarm setting range:

PV/SP alarm: -100 to 100 % of measured input range.

Deviation alarm: -100 to 100 % of measured input range width.

Output alarm: -5.0 to 105.0 % of output value.
Alarm hysteresis: 0.0 to 100.0 % of measured input range width.

Stand-by action:

Stand-by action can be set to make PV/ deviation alarm OFF during start-up or after SP change until SP reaches the normal region.

Other alarm actions:

Sensor grounding alarm: Detects sensor deterioration and outputs an alarm.

Fault diagnostic alarm:

Input burnout, A/D conversion error, RJC error
FAIL output:

Abnormality in Software, Abnormality in Hardware

Number of Instrument Alarm Settings: 4 points

Number of Instrument Alarm Outputs: Max. 4 points

One of PV alarm/Deviation alarm, Fault diagnostic alarm, Sensor grounding alarm and Fail output can be output with contact output.

(Note): Refer to the later "Contact Outputs" in Hardware Specifications.

Number of Event/Alarm Output

(See "Contact Output," later in this brochure.)

- As many as seven event and instrument alarms in combination can be output using contact outputs (standard feature). (Note that a control output relay can be used as the output device of time event number 5. This increases the number of contact outputs to eight.)
- Number of contact (relay) outputs:
 - 3 (standard), or 4 (if a control output relay is used as the output device of time event number 5)
- Number of contact (open-collector transistor) outputs:
 - 4 (standard)

From the above, up to 8 point outputs can be obtained.
- Any of Time Events, PV Events and Instrument Alarm function can be assigned to contacts for the above number of outputs. However, the timer delay alarm can be assigned to the first alarm output only. Also, the fifth time event is assignable only to the control output relay. Events and the alarm status can be read via communication in addition to output as the above alarm output.
- The controller is shipped from the factory with the following settings:
 - Number of time events: 4
 - Number of PV events: 2
 - Number of instrument alarms: 1

● Control Functions

UP Mode

The following types of basic control can be set as the UP mode by the user.

- Single-loop control (UP mode 1):
 - The most simple and basic control function.
- Cascade primary-loop control (UP mode 2):
 - Output tracking function and cascade control logic are provided. Suitable for primary-loop cascade control.
- Cascade control (UP mode 4):
 - Dual control function for cascade control in a single instrument.
- Loop control with PV switching (UP mode 6):
 - Two measured inputs are switched for control depending on the value of contact input or measured input.
- Loop control with PV auto-selector (UP mode 7):
 - Two measured inputs are automatically selected for control with a high, low, average or temperature-difference selector.

● Control Computation Functions

- In each UP mode, the following types of control computation can be selected:
 - Continuous PID control, Time proportional PID control, Position proportional PID control (for UP550-1□), Relay ON/OFF control, and Heating/Cooling control (for UP550-2□).
- Number of PID parameter sets:
 - Up to eight sets can be set; eight sets each for the main loop and slave loop in the case of cascade control.
- Auto-tuning: Available as standard. Possible to activate auto-tuning for both main and slave loops for cascade control.
- "SUPER" function:
 - Overshoots generated by abrupt changes in the target setpoint or by disturbances can be suppressed.

"SUPER 2" function:

This function stabilizes the state of control that is unstable due to hunting, etc. without requiring any change in PID constants, when the load and/or gain varies greatly, or when there is a difference between the characteristics of temperature zones.

Preset output function:

When the instrument is in Stop mode, measured input is burnt-out, or an abnormality is found in an input circuit, a preset setpoint is output as a control output.

Control cycle time

Each cycle time can be selected under the following conditions:

- 100 ms: Available when UP mode is not cascade control (UP mode 4).
- 200 ms: Available when UP mode is cascade control (UP mode 4).

(Set value when shipped from the factory: 200 ms)

Operation Mode Switching

(Note: Communication enables all the following mode switching to be executed.)

AUTO/MANUAL switching:

Bumpless switching between automatic operation mode and manual control mode is available by using instrument operation or contact input. The contact input has priority over instrument operation or switching by communication.

RUN (PRG)/STOP (RESET) switching:

Bumpless switching from Run to Stop mode is available by using the front key or contact input. The contact input has priority over the front key or switching by communication. Control computation is valid in Run mode but not in Stop mode. The preset value is output as a control output. Other functions operate normally.

CASCADE/Local SP switching:

Switching between the cascade, automatic and manual operating modes is available by using instrument operation or contact input when in Cascade control. The contact input has priority over instrument operation or switching by communication.

Control Parameters Setting Range

- Proportional band: 0.1 to 999.9%
 - 0.0 to 999.9% (for heating/cooling PID control), 0.0% available for ON/OFF control.
- Integral time: 1 to 6,000 s, or OFF (for Manual reset)
- Derivative time: 1 to 6,000 s, or OFF
- ON/OFF control hysteresis: 0.0 to 100.0% of measured input range width
- Preset output value: -5.0 to 105.0% (0 mA or less cannot be output)
- Output limiter:
 - Setting range: -5.0 to 105.0% for both high and low limits
 - However, "low limit setpoint < high limit setpoint" must be satisfied.
 - In case of heating/cooling PID control, upper limiter for heating and upper limiter for cooling.

Shutdown function:

When manual control is carried out with 4 to 20 mA output, control output can be output down to about 0 mA (shutdown is specified for -5.0% or less).

Rate-of-change limiter for output: OFF or 0.1 to 100.0%/s
 Deadband for heating/cooling control: -100.0 to 50.0% for output value

Deadband for position-proportional control: 1.0 to 10.0% for output

● Configuration of Input/Output Signal

Measured Input Computations

Input processing, Square root extraction (voltage input only, Input low cut 0.0 to 5.0%), Ten-segment linearizer function, Segment bios, Bias addition (-100.0 to 100.0%), and First order lag filter (off, time constant 1 to 120 s)

Auxiliary Input Computations

Input processing, Square root extraction (Input low cut 0.0 to 5.0%), Bias addition (-100.0 to 100.0%), Ratio multiplication (0.001 to 9.999), First order lag filter (OFF, time constant 1 to 120 s)

● Display and Operation Functions

PV Display

The controller display either PV1 or PV2 (only during cascade control), when switched, on the 5-digit display.

The number of display digits is 4 or 5. For thermocouple or RTD, data below the decimal point can be set not to display. The display range is -19999 to 30000 and the display span is 30000 or less. [550.00 appearing in the product photograph on page 1 cannot actually be displayed.]

LCD Display

Some data are displayed on LCD display unit. Each screen is called “display”.

Five types of display are provided; Operating display, Operating parameter setting display, Program parameters setting display, Setup parameter setting display and SELECT display.

Operating display:

Necessary data for operation is displayed according to UP mode.
 Such items as Program pattern, Setpoint, Control Output, control output bar, deviation

trend is displayed. Time base of deviation trend is 120 s to 20 h.

Operating parameters setting display:

The Operating parameters, which are mainly changed during operation, such as PID constant, are displayed.

Program Parameters Setting display:

Setting of Program pattern, stand-by action, parameters of Repeat action are displayed.

Setup Parameters Setting display:

The Setup parameters to configure functions of the instrument before starting operation are displayed. The explanation of each parameters is provided.

UT mode is set in this display.

SELECT display:

Up to five displays which are frequently accessed can be selected from Operating parameter setting display and Setup parameters setting display.

Status Lamps

Event indicator lamps:

Seven lamps, TME1, TME2, TME3, TME4, PVE1, PVE2, and AL1

Operation mode indicator lamps:

PRG (program operation), RST (operation at a stop), HLD (operation hold), LOC (local setting), MAN (manual operation), CAS (cascade operation), and PV2 (process variable 2)

Operation Keys

▲, ▼ keys: Increase or decrease setpoints and other parameters displayed on the LCD display.

DISP key: Switches from one data value to another on the LCD display.

SET/ENT key: Used for setting or changing set data, switching the LCD displayed contents, and switching operation modes except for A/M.

MODE key: Switches between the operating modes.

▽PT. No ▲ key:

Selects the pattern number.

RUN key: Initiates the program operation.

RESET key: Stop and reset the program operation.

Security Function

Key-lock from parameter setting and, operation can be inhibited by a password.



Status lamps
Indicates PV2 reading (PV2), time events (TIME1 to TIME4), PV events (PVE1 and PVE2), instrument alarm (AL1), program operation (PRG), stop of program operation (RST), operation hold (HLD), local operation (LOC), manual operation (MAN), and cascade operation (CAS).

Communication port for light loader
Parameters and programs are set via communication from a personal computer.

Operation keys
Increase/decrease the setpoint values (▲, ▼), switch between displays (DISP), switch between operation modes (MODE), select between parameters/set values (SET/ENT), switch between program patterns (△PT. No▽), start program operation (RUN), and stop program operation (RESET).

UP550

PV2
550.00

TIME
1: PRG
2: RST
3: HLD
4: LOC
MAN
CAS

MODE DISP ▾ ▲

▽PT.No ▲ RUN RESET

Measured value (PV) display unit
Displays PV and error codes when errors are detected.

LCD display unit
Displays the setpoint value (SP), program pattern, output value, bar graph (of deviations), deviation, deviation trend, valve opening, and the setting item and setting value of a parameter, etc.

Examples of Communication System Configuration Diagram

(1) Personal computer link communication/ MODBUS communication

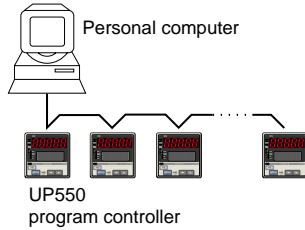

(2) Ladder communication

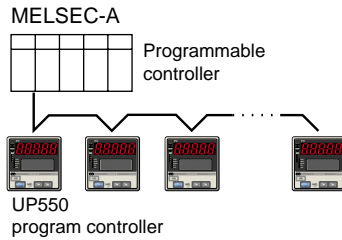

(3) Coordinated operation

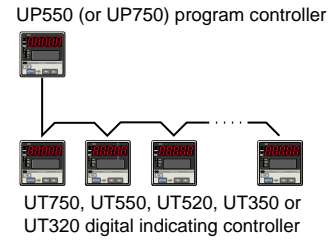

Input type		Input range code	Instrument range (°C)	Instrument range (°F)	Instrument accuracy*1	
Unspecified (When shipped from the factory)		OFF	Set the data item PV input type "IN 1" to the OFF option to leave the PV input type undefined.			
Thermocouple	K	typeK1 (1)	-270.0 to 1370.0°C	-450.0 to 2500.0°F	±0.1% ±1 digit of instrument range at 0°C or more ±0.2% ±1 digit of instrument range at less than 0°C • However, ±2% ±1 digit of instrument range for type K at temperatures less than -200°C. • However, ±1% ±1 digit of instrument range for type T at temperatures less than -200°C.	
		typeK2 (2)	-270.0 to 1000.0°C	-450.0 to 2300.0°F		
		typeK3 (3)	-200.0 to 500.0°C	-200.0 to 1000.0°F		
	J	typeJ (4)	-200.0 to 1200.0°C	-300.0 to 2300.0°F		
		typeT1 (5)	-270.0 to 400.0°C	-450.0 to 750.0°F		
	T	typeT2 (6)	0.0 to 400.0°C	-200.0 to 750.0°F		
		typeB (7)	0.0 to 1800.0°C	32 to 3300°F		±0.15% ±1 digit of instrument range at 400°C or more ±5% ±1 digit of instrument range at less than 400°C
	S	typeS (8)	0.0 to 1700.0°C	32 to 3100°F		±0.15% ±1 digit of instrument range
	R	typeR (9)	0.0 to 1700.0°C	32 to 3100°F		
	N	typeN (10)	-200.0 to 1300.0°C	-300.0 to 2400.0°F		±0.1% ±1 digit of instrument range ±0.25% ±1 digit of instrument range for temperature at less than 0°C
	E	typeE (11)	-270.0 to 1000.0°C	-450.0 to 1800.0°F		±0.1% ±1 digit of instrument range at 0°C or more ±0.2% ±1 digit of instrument range at less than 0°C • However, ±1.5% ±1 digit of instrument range for type E at temperature less than -200°C.
	L (DIN)	typeL (12)	-200.0 to 900.0°C	-300.0 to 1600.0°F		
	U (DIN)	typeU1 (13)	-200.0 to 400.0°C	-300.0 to 750.0°F		
		typeU2 (14)	0.0 to 400.0°C	-200.0 to 1000.0°F		
	W	typeW (15)	0.0 to 2300.0°C	32 to 4200°F		±0.2% ±1 digit of instrument range
Platinel 2	plati2 (16)	0.0 to 1390.0°C	32.0 to 2500.0°F	±0.1% ±1 digit of instrument range		
PR20-40	PR2040 (17)	0.0 to 1900.0°C	32 to 3400°F	±0.5% ±1 digit of instrument range at 800°C or more Accuracy not guaranteed for temperature less than 800°C		
RTD	W97Re3-W75Re25	W97Re3 (18)	0.0 to 2000.0°C	32 to 3600°F	±0.2% ±1 digit of instrument range	
		JPt100	JPt1 (30)	-200.0 to 500.0°C	-300.0 to 1000.0°F	±0.1% ±1 digit of instrument range (Note1) (Note2)
	Pt100	JPt2 (31)	-150.00 to 150.00°C	-200.0 to 300.0°F	±0.2% ±1 digit of instrument range (Note1)	
		Pt1 (35)	-200.0 to 850.0°C	-300.0 to 1560.0°F	±0.1% ±1 digit of instrument range (Note1) (Note2)	
		Pt2 (36)	-200.0 to 500.0°C	-300.0 to 1000.0°F		
Pt3 (37)	-150.00 to 150.00°C	-200.0 to 300.0°F	±0.2% ±1 digit of instrument range (Note1)			
Standard signal	0.4 to 2V	0.4 to 2V (40)	0.400 to 2.000 V	Display range -19999 to 30000 Display span 30000 or less (Decimal point position changeable)	±0.1% ±1 digit of instrument range	
	1 to 5V	1 to 5V (41)	1.000 to 5.000 V			
DC voltage	0 to 2V	0 to 2V (50)	0.000 to 2.000 V			
	0 to 10V	0 to 10V (51)	0.00 to 10.00 V			
	-10 to 20mV	mV1 (55)	-10.00 to 20.00 mV			
	0 to 100mV	mV2 (56)	0.0 to 100.0 mV			

Numbers in () are the measurement input range codes that apply when the communication function is used.

*1: Performance in the standard operating conditions (at 23±2°C, 55±10% RH, and 50/60 Hz power frequency)

Note 1: The accuracy is ±0.3°C of instrument range ±1 digit for a temperature range from 0 to 100°C

Note 2: The accuracy is ±0.5°C of instrument range ±1 digit for a temperature range from -100 to 200°C.

● Communications Function

(For UP550-□1 only)

This controller has 4 types of communication protocol with one communication interface. Communication is possible with personal computer, programmable logic controller, and other controllers.

Communication Protocol

Computer link communication:

Communication protocol with a personal computer.

Ladder communication:

Communication protocol with the ladder program on some programmable logic controllers.

MODBUS communication:

Communication protocol with a personal computer or PLC.

Coordinated operation:

Protocol used to communicate with more than one UT750, UT550, UT520, UT350 or UT320 controller. The UP550 always serves as the master station.

RS-485 Communication Interface

The RS-485 communication interface (conforms to EIA RS-485) can be used for computer link or ladder communication, or for coordinated operation.

Maximum number of connectable UP550's:

31 (total including other UT, UP, or UM models)

Maximum communication distance: 1200 m

Communication method:

Two-wire half-duplex or four-wire half-duplex, start-stop synchronization, and non-procedural

Communication rate: 600, 1200, 2400, 4800, or 9600 bps

■ Hardware Specifications

● Input/Output Signal Specifications

Measured Input Signal

Number of input points: 1 point

Input type, measurement range, and measurement accuracy:

The type of input and measurement range can be specified using the input range code shown in the table on page. 5.

Sampling period: 100, 200, or 500 ms (selectable)

Burnout detection: Activated for thermocouple (TC) input,

RTD input, or standard signal of 0.4 to 2 V DC or 1 to 5 V DC.

Possible to specify a travel of upscale, downscale, or off.

For standard signal input, set to burn out at Approx. 0.1V.

Input bias current: 0.05 μ A (for TC or RTD b-terminal)

Specified current(RTD): about 0.13 mA

Input resistance: 1 M Ω or more for TC or mV input

About 1 M Ω for DC voltage input

Allowable signal source resistance:

250 Ω or less for TC or mV input Signal source resistance effect 0.1 μ V/ Ω or less 2 k Ω or less for DC voltage input

Allowable signal source resistance effect: 0.01%/100 Ω or less

Allowable leadwire resistance (for RTD input):

Maximum 150 Ω /one wire (Lead resistances of three wires must be equal.)

However, it must be 10 Ω /one wire for the range of -150.0 to 150.0°C.

Effect of wiring resistance: $\pm 0.1^\circ\text{C}/10 \Omega$

Allowable input voltage:

± 10 V DC for TC/mV/RTD input

± 20 V DC for DC voltage input

Noise rejection ratio:

Normal mode 40 dB (50/60 Hz) or more

Common mode 120 dB (50/60 Hz) or more

Reference junction compensation error:

$\pm 1.0^\circ\text{C}$ (15 to 35°C), $\pm 1.5^\circ\text{C}$ (0 to 15°C and 35 to 50°C)

Applicable standards: JIS, IEC, and DIN (ITS-90) for TC and RTD

Auxiliary Analog Input

(For UP550-□1 only)

Functions: PV input to secondary-loop of cascade control, etc.

Input type: Settable within the range of voltage input 0 to 2 V DC, 0 to 10 V DC, 0.4 to 2.0 V DC or 1 to 5 V DC.

Number of inputs: 1 point

Sampling period: 100, 200 or 500 ms

auxiliary analog input period is linked with PV sampling period.

Input resistance: Approx. 1 M Ω

Input accuracy: $\pm 0.3\%$ ± 1 digit of F.S. for 0 to 2 V DC input

$\pm 0.2\%$ ± 1 digit of F.S. for 0 to 10 V DC input

$\pm 0.375\%$ ± 1 digit of F.S. for 0.4 to 2.0 V DC input.

$\pm 0.3\%$ ± 1 digit of F.S. for 1 to 5 V DC input.

Performance in the standard operating conditions (at $23 \pm 2^\circ\text{C}$, $55 \pm 10\%$ RH, and 50/60 Hz power frequency)

Feedback Resistance Input

(For UP550-1□ only)

Effective for position proportional PID control only

Slidewire resistance:

Total resistance 100 Ω to 2.5 k Ω (with detection of slidewire breakage)

Measuring resolution $\pm 0.1\%$ of total resistance

Retransmission Output

Any of the measured value, target setpoint or control output is output. This output can be used for the 15 V DC loop power supply sensor.

Number of output points: 1 or 2 (depend on selection of control output)

Retransmission output 2 is available only when "relay" is selected as the control function.

Output signal: 4 to 20 mA DC, 0 to 20 mA DC, 20 to 4 mA DC or 20 to 0 mA DC (0 mA or less cannot be output)

Load resistance: 600 Ω or less

Output accuracy: $\pm 0.1\%$ of span ($\pm 5\%$ for 1 mA or less)

Performance in the standard operating conditions (at $23 \pm 2^\circ\text{C}$, $55 \pm 10\%$ RH, and 50/60 Hz power frequency)

When using for 15 V DC loop power supply:

Supply voltage 14.5 to 18.0 V DC, maximum supply current about 21 mA (with the protection circuit at field short-circuit)

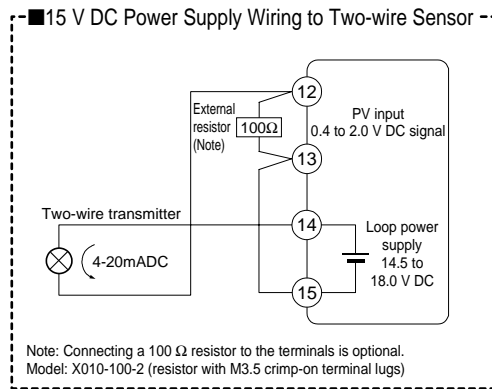

Control Outputs

Select 1 point (UP550-0□) or 2 points (UP550-2□) from the following output types depending on the model code. Relay contact output for position-proportional PID control (UP550-1□).

Current output

- Number of output points: 1 or 2 (for heating/cooling type) (switchable to voltage pulse output)
- Output signal: 4 to 20 mA DC, 0 to 20 mA DC, 20 to 4 mA DC or 20 to 0 mA DC
- Load resistance: 600 Ω or less
- Output accuracy: ±0.1% of span (±5% for 1 mA or less)
- Performance in the standard operating conditions (at 23± 2°C, 55± 10% RH, and 50/60 Hz power frequency)

Voltage pulse output

- Number of output points: 1 or 2 (for heating/cooling type) (switchable to current output)
- Output signal: On voltage 12 V DC or more (load resistance 600 Ω or more)
- Off voltage 0.1 V DC or less
- Resolution: 10 ms or 0.1% of output value, whichever is greater

Relay contact output

- Number of output points: 1 or 2 (for heating/cooling type)
- Output signal: At three terminals of NC, NO and Common
- Contact rating: 250 V AC, 3 A or 30 V DC, 3 A (resistive load)
- Resolution: 10 ms or 0.1% of output value, whichever is greater

Contact Inputs

Application: Program pattern switching, Local/Remote switching, PRG/RESET switching, Pause of operation, Advance of program, Measured input switching, and display of messages.

Number of input points:

- 7 (UP550-□0)
- 8 (UP550-□1)

Input type: Non-voltage contact input or transistor open collector input

Input contact rating: 12 V DC, 10 mA or more

On/off detection:

- For non-voltage contact input,
 - On contact resistance 1 kΩ or less;
 - Off contact resistance 20 kΩ or more
- For open-collector transistor input,
 - On 2 V or less;
 - Off leak current 100 μA or less

Minimum retention time for status detection: PV input sampling period ×3

Contact Outputs

Application: Time event outputs, PV event outputs, and instrument alarm outputs

Number of outputs: 7 points (3 relay-contact outputs and 4 transistor outputs), where a control output relay can be used as a contact-output relay for time event No. 5 if no relays are in use for control output. This enables the number of outputs (seven) to be increased to eight by adding one more relay output.

Relay contact rating: 240 V AC, 1 A or 30 V DC, 1 A (Common to COM terminal)

Transistor contact rating: 24 V DC, 50 mA (Common to COM terminal)

● **Display Specifications**

Measured value (PV) display:

5 digit seven-segment red color LED display; height of letters 20 mm

Data display: 32 × 128 dot-matrix LCD display with back-light

Status indicator lamps: LEDs

● **Conformance to Safety and EMC Standards**

Safety: Compliant with IEC/EN61010-1: 2001, approved by CSA1010, approved by UL508.

Installation category : CAT. II (IEC/EN61010, CSA1010) Pollution degree : 2 (IEC/EN61010, CSA1010)

Measurement category : I (CAT. I : IEC/EN61010)

Rated measurement input voltage : 10V DC max.(across terminals), 300V AC max.(across ground)

Rated transient overvoltage : 1500V (Note)

Note : It is a value on the safety standard which is assumed by IEC/EN61010-1 in measurement category I, and is not the value which guarantees an apparatus performance.

EMC standards: Complies with EN61326

During test, the controller continues to operate with the measurement accuracy within ±20% of the range.

● **Construction, Installation, and Wiring**

Construction: Dust-proof and Drip-proof front panel conforming to IP55.

For side-by-side close installation, controller loses its dust-proof and drip-proof protection.

Material of the body: ABS resin and polycarbonate

Case color: Black

Weight: Approx. 1 kg or less

External dimensions: 96W × 96H × 100D (from the panel face) (mm)

Mounting: Direct panel mounting; mounting bracket, one each for upper and lower mounting

Panel cutout dimensions: 92^{+0.8}₀W × 92^{+0.8}₀H (mm)

Tilting: Up to 30 degrees from horizontal; Must not face downward.

Wiring connection: With M3.5 screw terminals (for signal, power and grounding wiring)

● Power Supply and Isolation

- Power supply: Rated voltage 100 to 240 V AC ($\pm 10\%$), 50/60 Hz
- Power consumption: MAX. 20 VA or less (MAX. 8.0 W)
- Lithium battery: For memory backup. Service life approx. 10 years
- Withstanding voltage:
1500 V AC for 1 min.
 between primary terminals and secondary terminals
- 1500 V AC for 1 min.
 between primary terminals and ground terminal
- 1500 V AC for 1 min.
 between ground terminal and secondary terminals
- 500 V AC for 1 min.
 between secondary terminals
 (where primary terminals stand for power and relay output terminals and secondary terminals stand for analog input or output signal terminals, voltage pulse output terminals, and contact input terminals.)
- Isolation resistance:
20 M Ω or more for 500 V DC applied
 between power terminals and ground terminal
- Grounding: Class D grounding (grounding resistance of 100 Ω or less).

Isolation Specifications

- Measured input terminal:
 Isolated from other input/output terminals, but not isolated from internal circuits.
- Auxiliary analog input terminal:
 Isolated from other input/output terminals and internal circuits.
- Control output (current output or voltage pulse output) and retransmission output: Not isolated between control output and retransmission output, but isolated from other input/output terminals and internal circuits.
- Relay contact control output terminals:
 Isolated from other input/output terminals and internal circuits.
- Contact input terminals:
 Not isolated from other contact input terminals and communication terminals, but isolated from other input/output terminals and internal circuits.
- Relay contact output terminals:
 Isolated from other input/output terminals and internal circuits.
- Transistor contact output terminals:
 Not isolated from other contact outputs, but isolated from other input/output terminals and internal circuits.
- RS-485 communication terminals:
 Not isolated from contact input terminals, but isolated from other input/output terminals and internal circuits.
- Feedback slide wire resistance input terminals:
 Not isolated from control output (current or voltage pulse control output) and retransmission output terminals.
 Isolated from other input/output terminals and internal circuit.

Power terminals:

 Isolated from other input/output terminals and internal circuits.

Ground terminal:

 Isolated from other input/output terminals and internal circuits.

● Environmental Conditions

Normal operating conditions:

 Ambient temperature: 0 to 50°C (40°C or less in close mounting side-by-side)

 Temperature change rate: 10°C/h or less

 Ambient humidity: 20 to 90% RH (no condensation)

 Magnetic field: 400 A/m or less

 Continuous vibration (5 to 14 Hz): Peak-to-peak amplitude 1.2 mm or less

 Continuous vibration (14 to 150 Hz): 4.9 mm/s² or less

 Short period vibration: 14.7 μ s², 15 s or less

 Shock: 147 m/s² or less, 11 ms

 Installation altitude: 2000 m or less above sea level

 Warm-up time: 30 minutes or more

Transportation and storage conditions:

 Temperature: -25 to 70°C

 Temperature change rate: 20°C/h or less

 Humidity: 5 to 95% RH (no condensation)

Effect of operating conditions

 Effect of ambient temperature:

 Whichever is greater, $\pm 1 \mu\text{V}/^\circ\text{C}$ or $\pm 0.01\%$ of F.S./ $^\circ\text{C}$ for voltage or thermocouple inputs.

$\pm 0.02\%$ of F.S./ $^\circ\text{C}$ for Auxiliary input

$\pm 0.05^\circ\text{C}/^\circ\text{C}$ (ambient temperature) or less for RTD inputs.

$\pm 0.05\%$ of F.S./ $^\circ\text{C}$ or less for analog outputs.

 Effect of voltage fluctuation

 (within rated voltage range):

 Whichever is greater, $\pm 1 \text{ mV}/10 \text{ V}$ or

$\pm 0.01\%$ of F.S./10 V for analog inputs.

$\pm 0.05\%$ of F.S./10 V or less for analog outputs.

■ Fuction Block Diagram for Single-loop Control

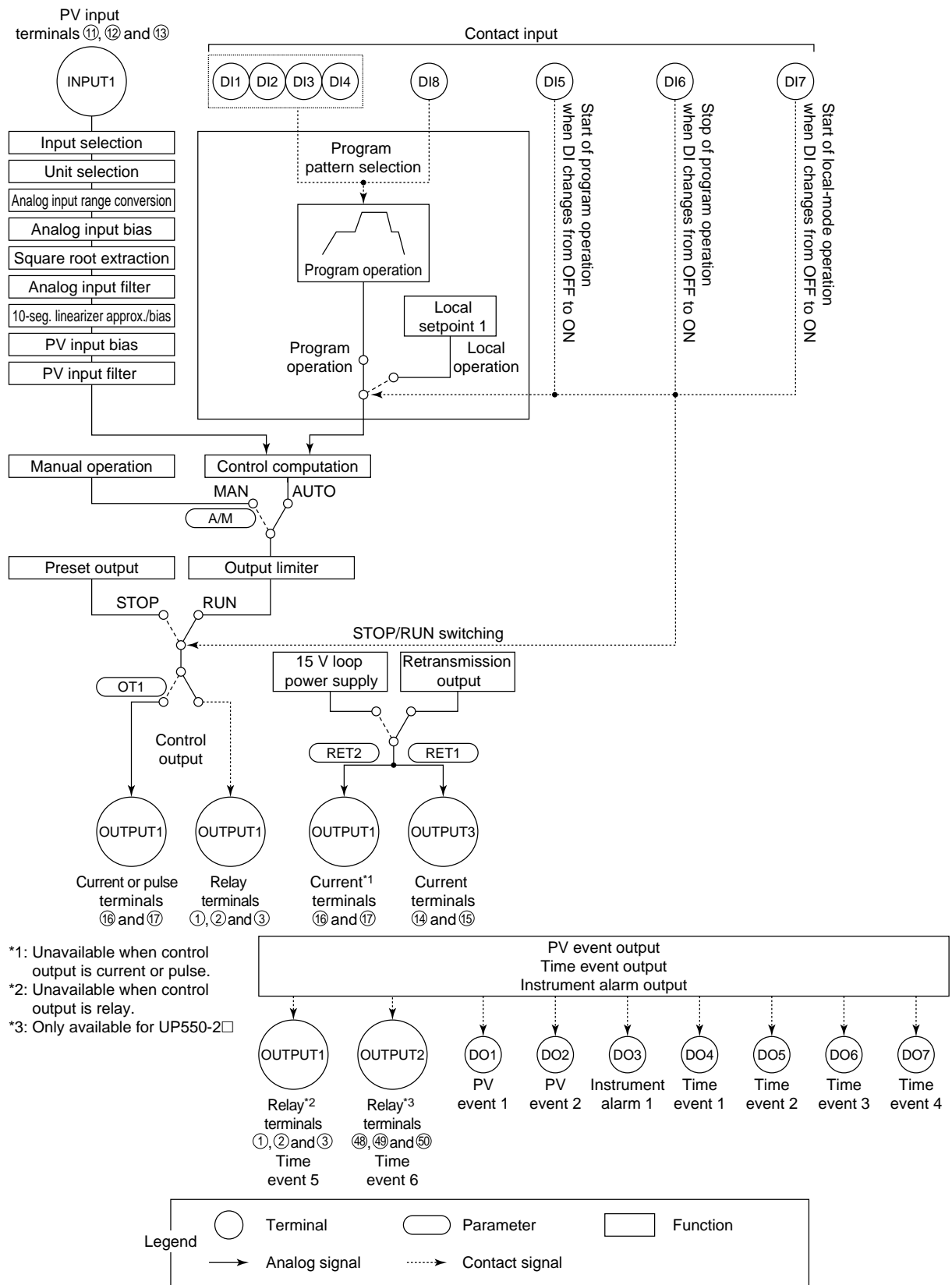

*1: Unavailable when control output is current or pulse.
 *2: Unavailable when control output is relay.
 *3: Only available for UP550-2□

Function Block Diagram for Cascade Control

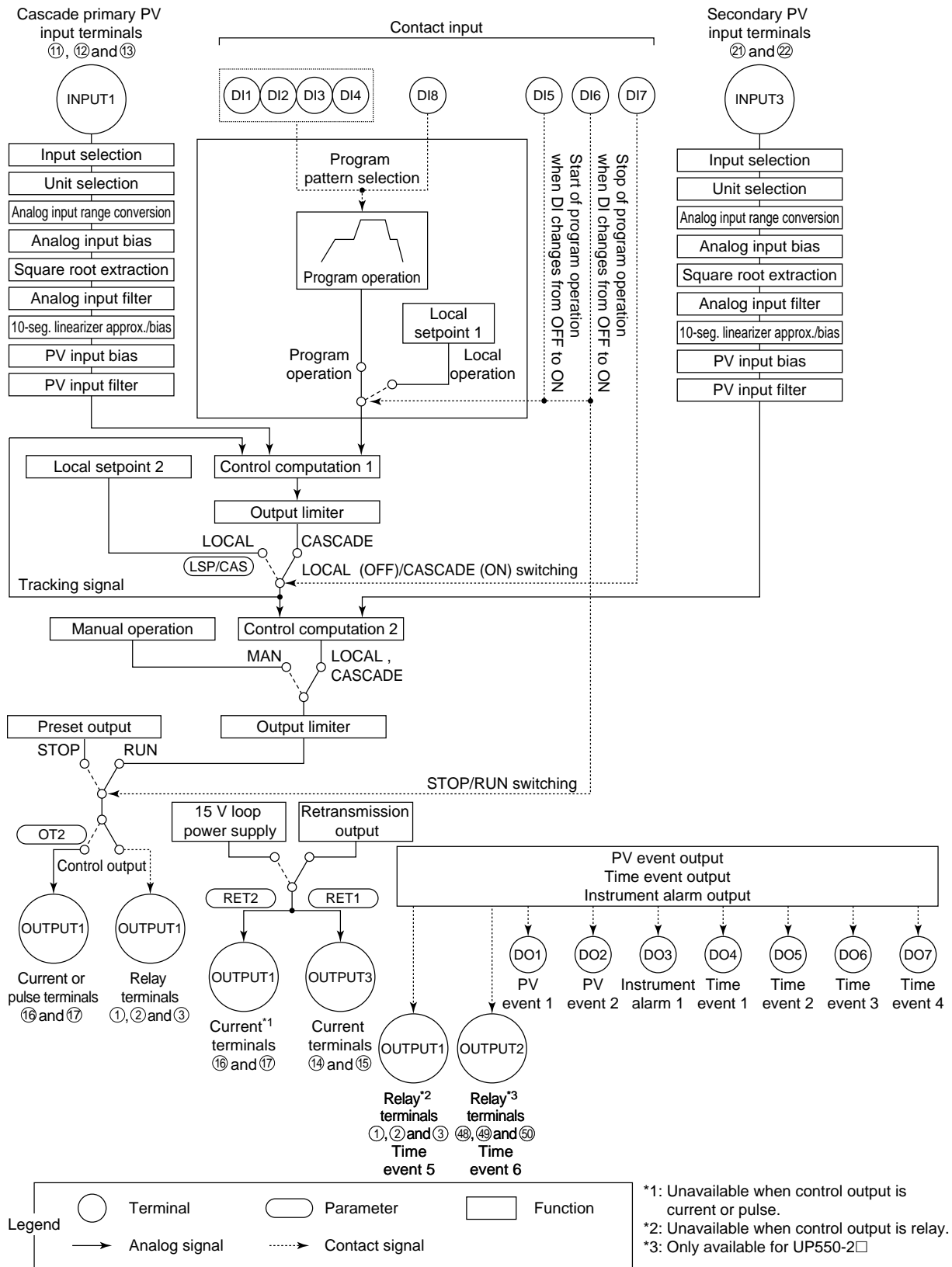

■ Fuction Block Diagram for Loop Control with PV Switching

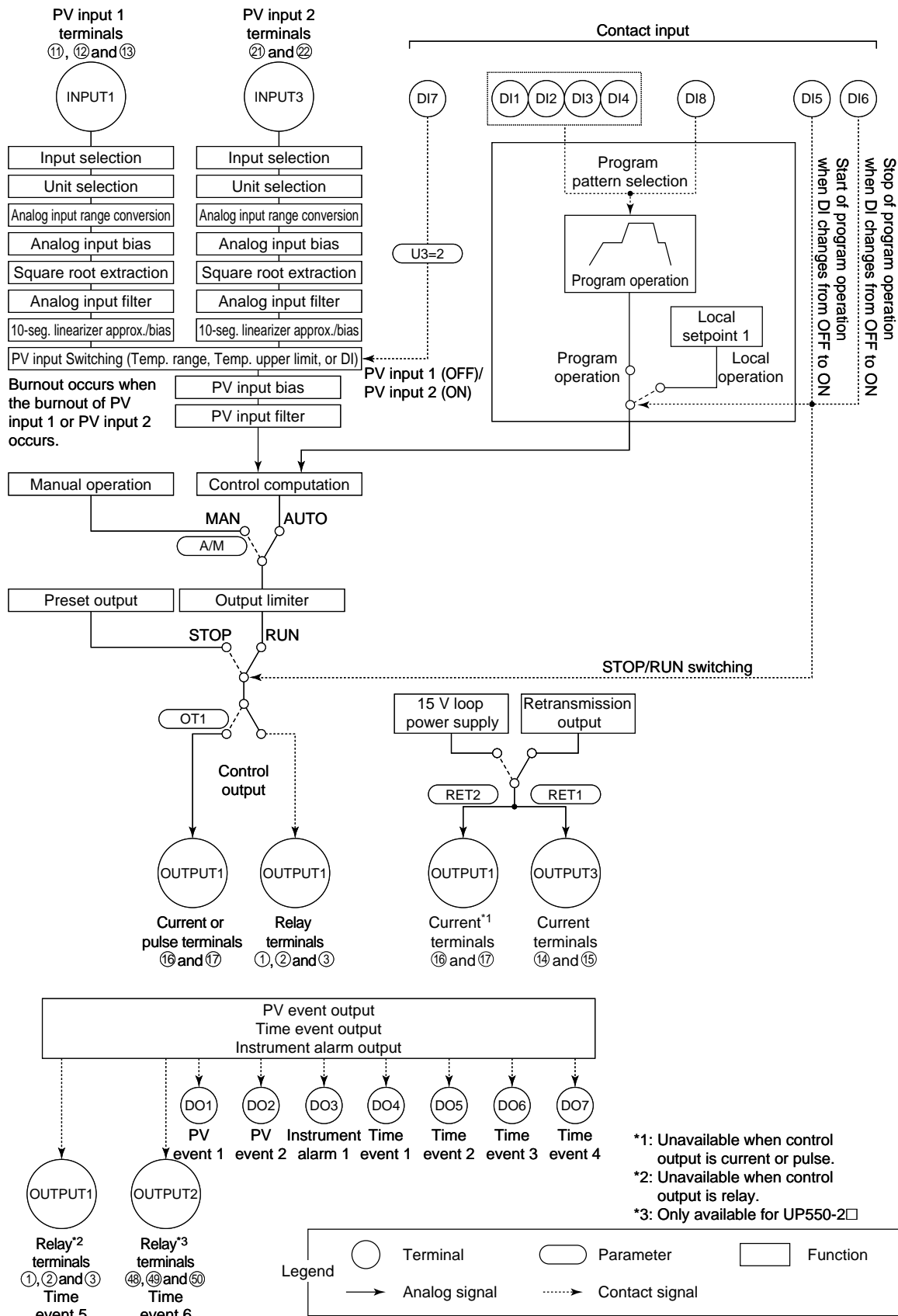

UP550 Standard Type (Model UP550-0□), Single-loop Control

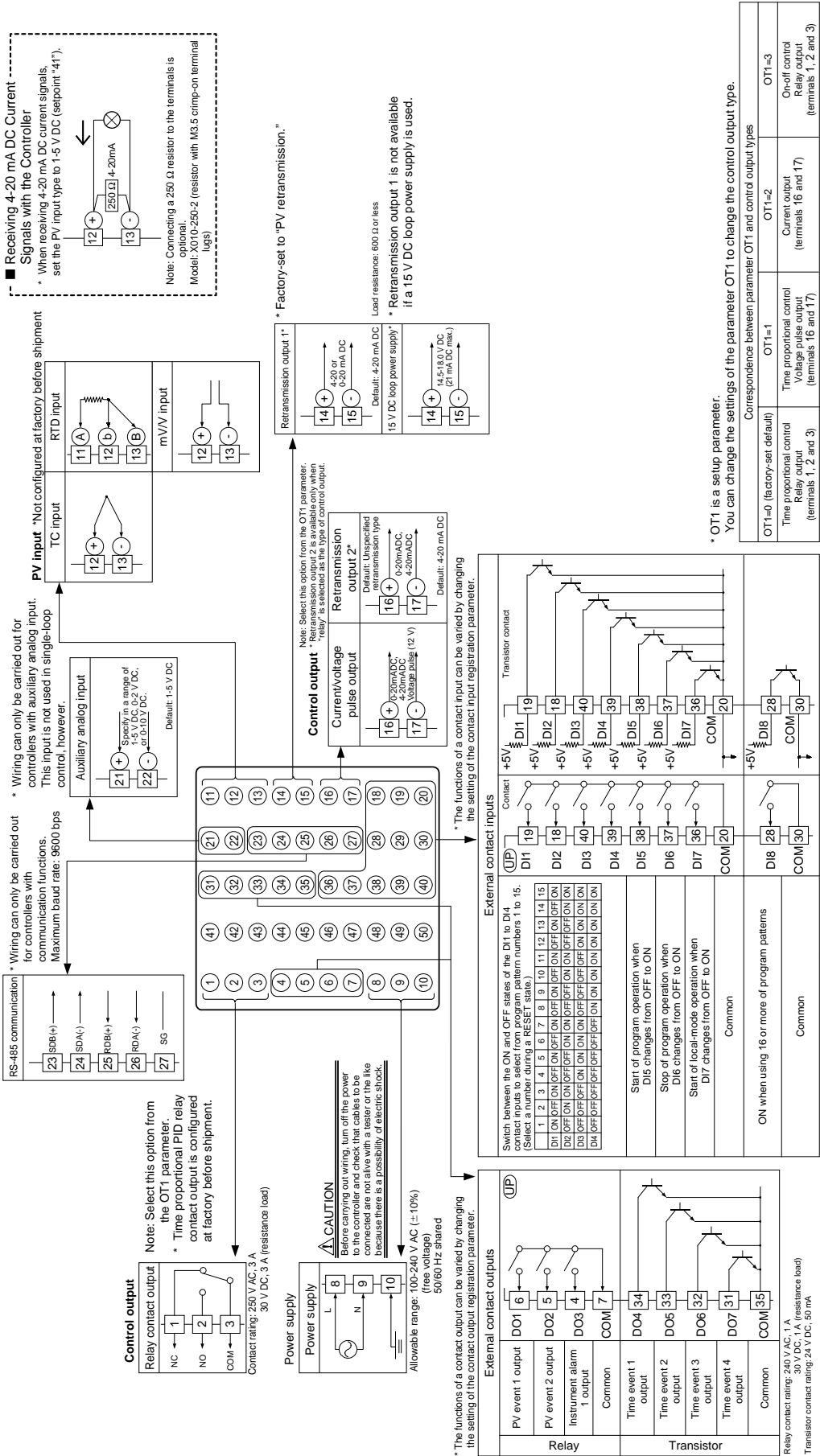

UP550 Standard Type (Model UP550-0□), Cascade Control

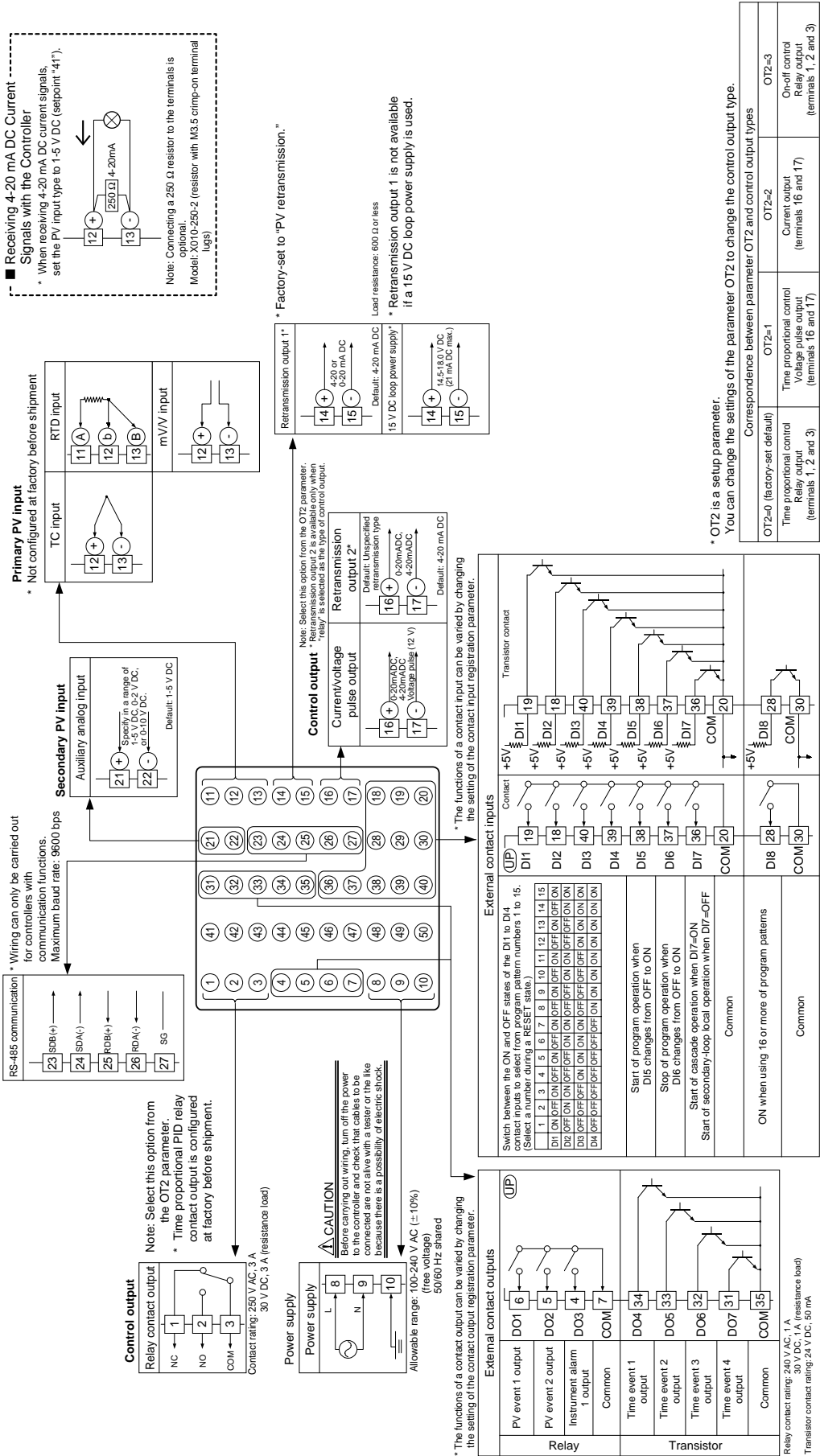

UP550 Standard Type (Model UP550-□□), Loop Control with PV Switching

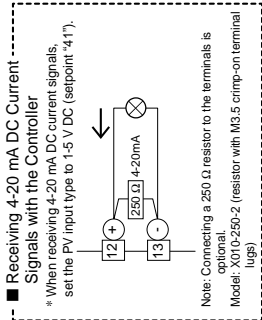
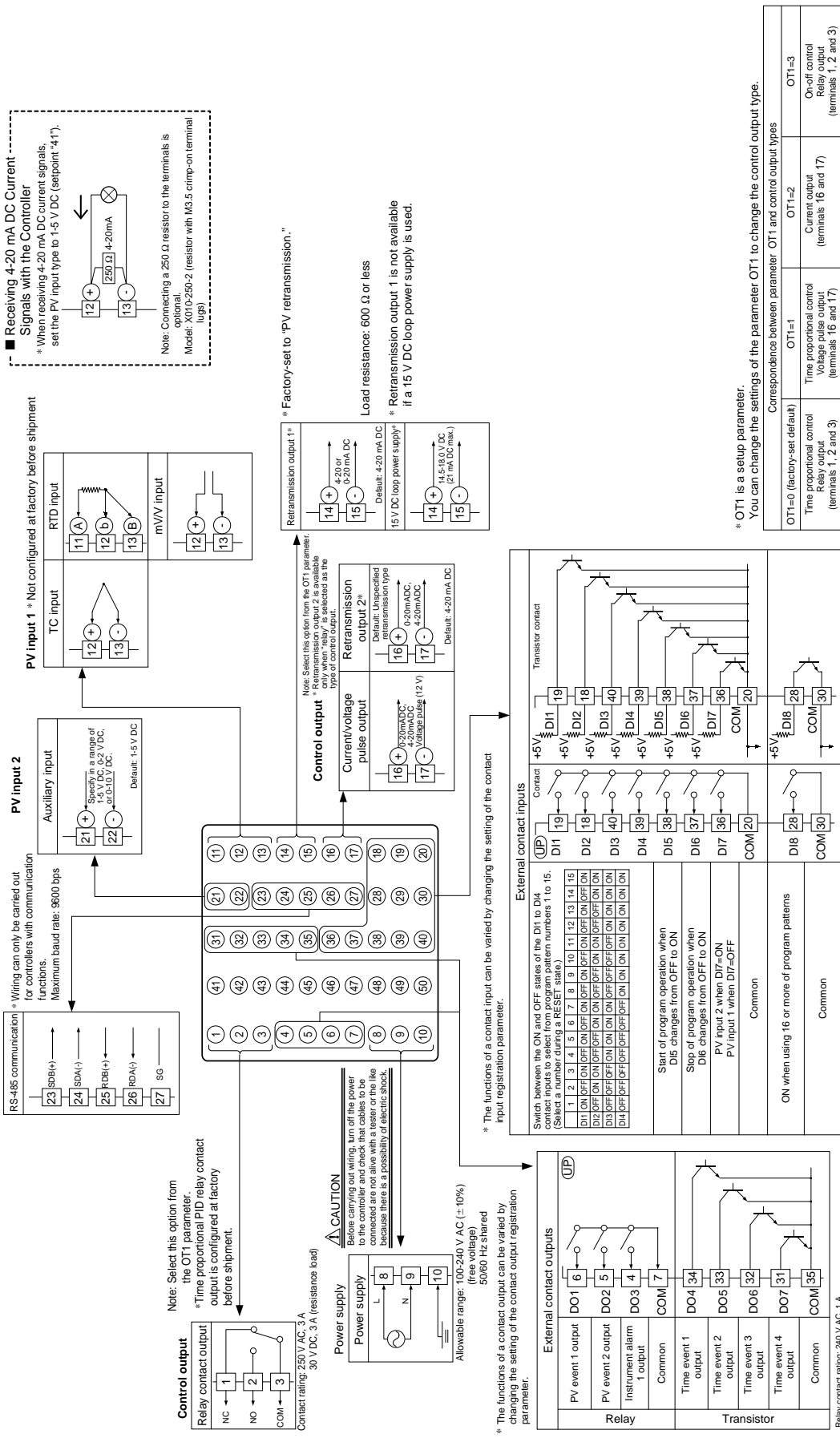

* Factory-set to "PV retransmission."
 Load resistance: 600 Ω or less
 * Retransmission output 1 is not available if a 15 V DC loop power supply is used.

* OT1 is a setup parameter. You can change the settings of the parameter OT1 to change the control output type.

Correspondence between parameter OT1 and control output types	
OT1=0 (factory-set default)	OT1=2
Time proportional control Relay output (terminals 16 and 17)	Current output (terminals 16 and 17)
OT1=1	OT1=3
Time proportional control Voltage pulse output (terminals 16 and 17)	On-off control Relay output (terminals 1, 2 and 3)

External Dimensions and Panel Cutout Dimension

Unit: mm

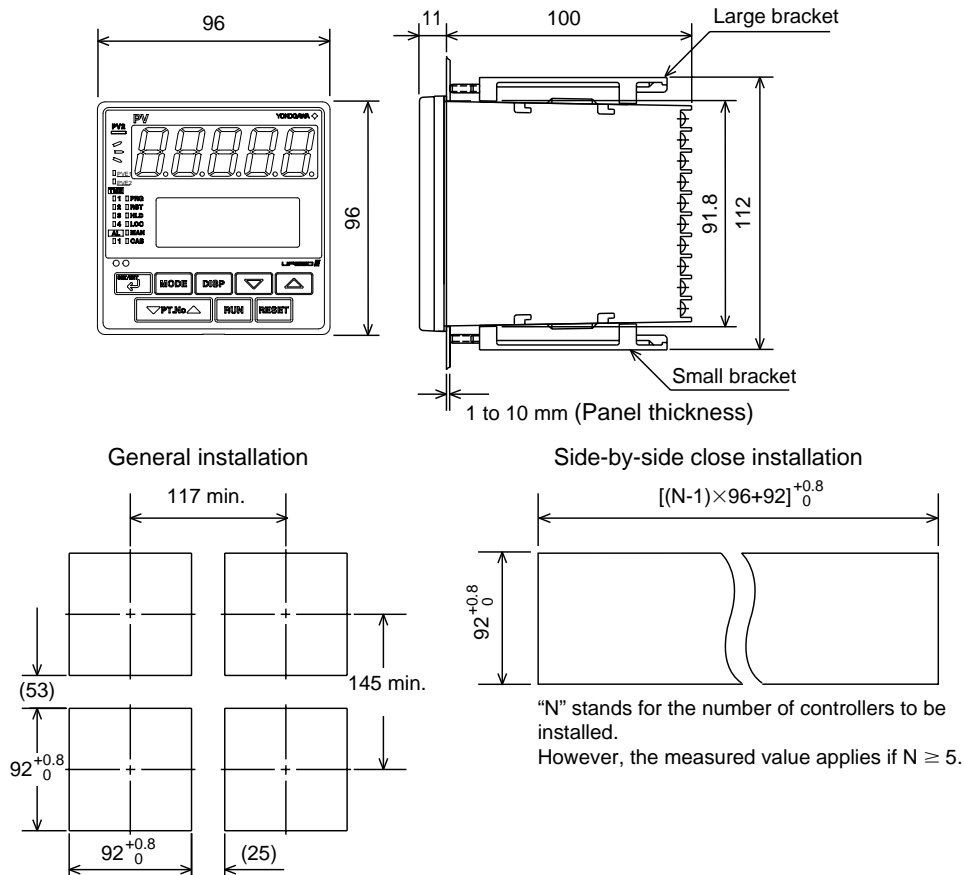

Model and Suffix Codes

Model	Suffix Code	Description
UP550		Program controller (provided with retransmission output and 15 V DC loop power supply as standard)
Type	-0	Standard type
	-1	Position proportional type
	-2	Heating/cooling type
Optional functions	0	None
	1	With communication, auxiliary analog input, and 1 additional DI

Standard accessories: Brackets (mounting hardware), unit label, User's Manuals, and User's Manual (reference) (CD-ROM version).

Specify the suffix code of option 1 depending on the UP mode to be used.

Correspondence between UT mode and suffix code

UP mode	Suffix code →	00, 20	01, 21	10	11	Remarks
Single-loop control	(UP mode 1)	App.	App.	App.	App.	
Cascade primary-loop control	(UP mode 2)	N/A	App.	N/A	N/A	
Cascade control	(UP mode 4)	N/A	App.	N/A	App.	An auxiliary analog input is used as cascade input.
Loop control with PV switching	(UP mode 6)	N/A	App.	N/A	App.	An auxiliary analog input is used as the PV input 2.
Loop control with PV auto-selector	(UP mode 7)	N/A	App.	N/A	App.	An auxiliary analog input is used as the PV input 2.

App.: Function available, N/A: Function not available

■ Correspondence between the Model and Suffix Codes, and the Contact Input/Output Terminals Provided

Check the model ordered and the presence/absence of contact inputs and outputs in the following table.

✓ indicate that the contacts are available.

Model and Suffix Codes	Contact input terminals								Contact output terminals						
	DI1	DI2	DI3	DI4	DI5	DI6	DI7	DI8	DO1	DO2	DO3	DO4	DO5	DO6	DO7
UP550-□ 0	✓	✓	✓	✓	✓	✓	✓		✓	✓	✓	✓	✓	✓	✓
UP550-□ 1	✓	✓	✓	✓	✓	✓	✓	✓	✓	✓	✓	✓	✓	✓	✓

■ Items to Be Specified When Ordering

Model and suffix codes, necessary/unnecessary of User's Manual or QIC.