

General Specifications

Model UM330 Digital Indicator with Alarms



GS 05F01D02-02E

■ General

Model UM330 Digital Indicator with Alarms is a precision alarm instrument with universal input 1/8DIN. For excellent monitoring operability, it displays process variables on a large display. It is also provided with four alarm setting points (or setting outputs; one is optional). A retransmission output and 15 V DC loop power supply are provided as standard. A communication function or 24 V DC loop power supply is available optionally.

■ Main Features

- Extra-large digital display allows the indicated values to be read even from a long distance. LEDs of 20mm height are used for the process variable display.
- Universal input allows simple setting of the input types (TC, RTD, DCV) or input measuring range.
- Various communication function are provided. Communication is possible with personal computer and programable logic controller.

■ Function Specifications

● Signal Computation Function

- Measured input computation:
- Bias addition (-100.0 to 100.0% of measured input range width.), first-order lag filter (time constant off, 1 to 120 s.)
- Contact input: Retains and displays maximum and minimum readings from measured variable. Resets the maximum and minimum readings.

UM330



UM330E

"E" indicates the model with expanded functions.



● Alarm Function

Six different types of alarms are provided. If an alarm occurs, the alarm lamp indicates it. Four (one is optional) of the six can be used as relay contact outputs.

Alarm types:

- PV high limit, PV low limit, Deenergized on PV high limit, Deenergized on PV low limit, Fault diagnosis, and FAIL output

Setting ranges for process variable alarms:

- PV alarms; -100.0 to 100.0% of measured input range.
- Alarm hysteresis width; 0.0 to 100.0% of measured input range width.

Delay timer:

- 0.00 to 99.59 (minute, second)
- An alarm is output when the delay timer expires after the alarm setpoint is reached.
- Setting for each alarm is possible.

Fault diagnosis alarm: Input burn out, A/D conversion error, TC RJC error

FAIL output: Software failure, hardware failure

Stand-by action:

- Stand-by action can be set to make PV alarm OFF during start-up.

● Display and Operation function

PV display:

- 4-digit digital display for engineering data

Parameter display:

- 4-digit digital display for various data, including parameters

Status display: 4 alarm LEDs (AL1, AL2, AL3, AL4)

Operation keys: Δ and ∇ keys: Increase/decrease setpoints or various parameters.

SET/ENT key: Sets setpoint data, calls or switches various parameters.

SELECT display:
 Allows selection and registration of frequently changed parameters from the operation parameters during operation. For example, if the first alarm setpoint is registered in the SELECT display, the setpoint can easily be displayed during operation.

Security function:
 An operation inhibiting mode using a password is provided.

● **Communication Functions (optional)**

The communication function, provided with the instrument, allows connection to a personal computer, and programmable logic controller.

Communication protocol
Computer link communication:
 Communication protocol with a personal computer

Ladder communication:
 Communication protocol with programmable logic controller.

MODBUS Communication:
 Communication protocol with a personal computer or PLC.

Communication interface
Communication protocol:
 Computer link, ladder communication or MODBUS communication

Standard: EIA RS485

Maximum number of connectable controllers:
 31 GREEN series controllers

Maximum communication distance: 1,200 m

Communication method:
 Two-wire half duplex, or four-wire half duplex, start-stop synchronization system, protocol free

Communication rate: 600, 1200, 2400, 4800, 9600 bps

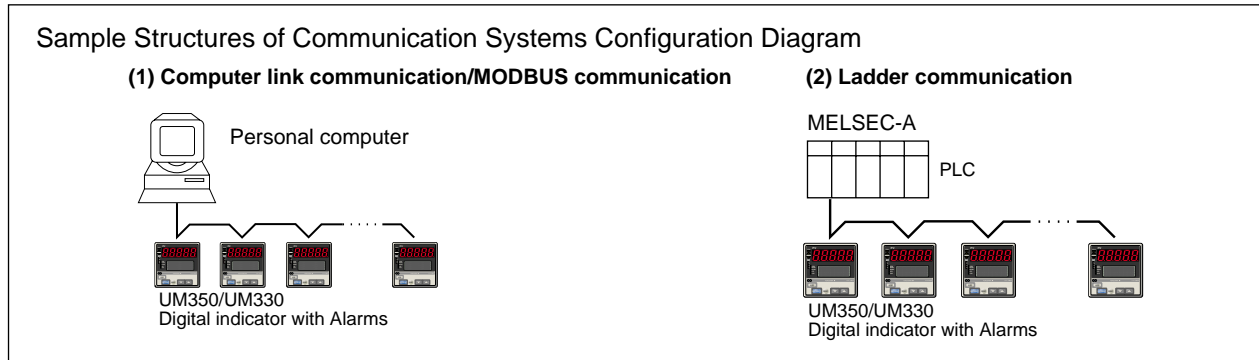
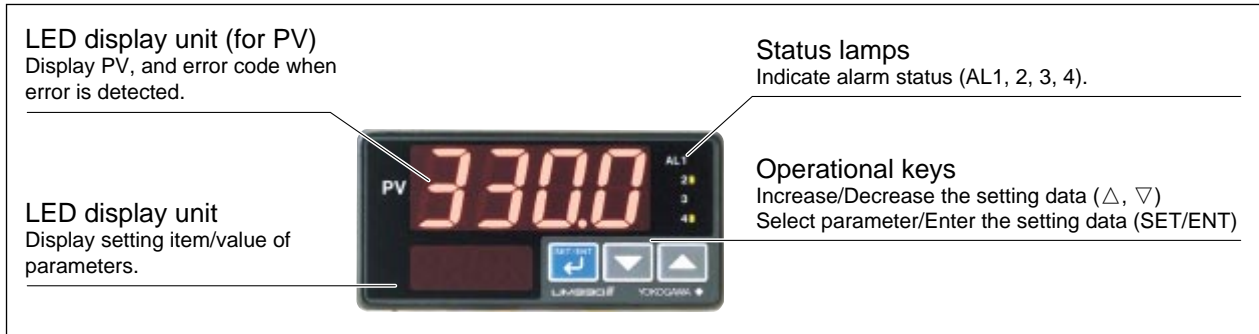

Hardware Specifications

Measured input signal

Number of inputs: 1

Input type, measurement range, and measurement

accuracy:

The type of input and measurement range can be specified using the input range code shown in the table below by front key operation or communication.

Sampling period: 250ms

Burnout detection:

Available with TC, RTD, standard signal, 0.4 to 2V DC and 1 to 5V DC.

Up-scale, down-scale, and off can be set.

For standard signal, an input of 0.1V or less is regarded as burnout.

Input bias current: 0.05 μA (for TC and RTD b-terminal)

Measuring current(RTD): about 0.13mA

Input resistance:

TC/mV: 1 MΩ or more

DC voltage input: Approximately 1 MΩ

Allowable signal source resistance:

TC/mV input: 250Ω or less

Effect from allowable signal source

resistance:0.1 μV/Ω or less

DC voltage input: 2 kΩ or less

Effect from allowable signal source

resistance:

0.01%/100Ω or less

Allowable leadwire resistance:

RTD 150Ω/wire or less (provided that there is no variation between the three wires.)

For the range of -150.0 to 150.0, 10Ω/wire

Effect from allowable leadwire resistance:

±0.1°C/10Ω or less

Allowable input voltage:

TC/mV/RTD ±10V DC

DC voltage ±20V DC

Noise rejection ratio:

Normal mode 40dB (50/60Hz) or more

Common mode 120dB (50/60Hz) or more

Reference-junction compensation error:

±1.0°C (15 to 35 °C),

±1.5°C (0 to 15°C, 35 to 50°C)

Applicable standard: For TC and RTD, JIS, IEC, DIN(ITS-90)

Input Type		Input range code	Instrument range (°C)	Instrument range (°F)	Measurement accuracy*1
Unspecified(when shipped from the factory)		OFF	Set the data item PV input Type "IN" to the OFF option to leave the PV input type undefined.		
Thermocouple	K	1	-200 to 1370°C	-300 to 2500°F	At or above 0°C ±0.1% ±1 digit of F.S.
		2	-199.9 to 999.9°C	0 to 2300°F	Below 0°C, ±0.2% ±1 digit of F.S.
		3	-199.9 to 500.0°C	-199.9 to 999.9°F	
	J	4	-199.9 to 999.9°C	-300 to 2300°F	
	T	5	-199.9 to 400.0°C	-300 to 750°F	
		6	0.0 to 400.0°C	-199.9 to 750.0°F	
	B	7	0 to 1800°C	32 to 3300°F	At or above 400°C ±0.15% ±1 digit of F.S. Below 400°C ±5% ±1 digit of F.S.
	S	8	0 to 1700°C	32 to 3100°F	±0.15% ±1 digit of F.S.
	R	9	0 to 1700°C	32 to 3100°F	
	N	10	-200 to 1300°C	-300 to 2400°F	±0.1% ±1 digit of F.S. Below 0°C ±0.25% ±1 digit of F.S.
	E	11	-199.9 to 999.9°C	-300 to 1800°F	At or above 0°C ±0.1% ±1 digit of F.S.
	L (DIN)	12	-199.9 to 900.0°C	-300 to 1300°F	Below 0°C ±0.2% ±1 digit of F.S.
	U (DIN)	13	-199.9 to 400.0°C	-300 to 750°F	
		14	0.0 to 400.0°C	-199.9 to 750.0°F	
	W (DIN)	15	0 to 2300°C	32 to 4200°F	±0.2% ±1 digit of F.S.
	Platinel 2	16	0 to 1390°C	32 to 2500°F	±0.1% ±1 digit of F.S.
	PR20-40	17	0 to 1900°C	32 to 3400°F	At or above 800°C ±0.5% ±1 digit of F.S. Below 800°C, not guaranteed
	W97Re3-W75Re25	18	0 to 2000°C	32 to 3600°F	±0.2% ±1 digit of F.S. (Note1) (Note2)
RTD	JPt100	30	-199.9 to 500.0°C	-199.9 to 999.9°F	±0.1% ±1 digit of F.S. (Note1)
		31	-150.0 to 150.0°C	-199.9 to 300.0°F	±0.2% ±1 digit of F.S. (Note1) (Note2)
	Pt100	35	-199.9 to 850.0°C	-300 to 1560°F	±0.1% ±1 digit of F.S. (Note1)
		36	-199.9 to 500.0°C	-199.9 to 999.9°F	
		37	-150.0 to 150.0°C	-199.9 to 300.0°F	±0.2% ±1 digit of F.S.
Standard signal	0.4 to 2V	40	0.400 to 2.000	Scaling is enable in the following 4 range.	±0.1% ±1 digit of F.S.
	1 to 5V	41	1.000 to 5.000		
DC voltage	0 to 2V	50	0.000 to 2.000	-1999 to 9999	
	0 to 10V	51	0.00 to 10.00	-199.9 to 999.9	
	-10 to 20mV	55	-10.00 to 20.00	-19.99 to 99.99	
	0 to 100mV	56	0.0 to 100.0	-1.999 to 9.999	

Note 1 : The accuracy is ±0.3°C of instrument range ± 1 digit for a temperature range from 0 to 100°C

Note 2 : The accuracy is ±0.5°C of instrument range ± 1 digit for a temperature range from -100 to 200°C.

*1 Performance in the standard operating conditions (at 23±2°C, 55±10% RH, and 50/60 Hz power frequency)

24V DC Loop Power Supply for Sensor

Supplies power to the 2-wire transmitter. A resistor (10 to 250Ω) is to be placed between the alarm unit and transmitter. Current signals are converted into voltage signals, and read through the process input.

Supply voltage is 21.6 to 28.0V DC, maximum supply current is about 30mA (only for models with 24V DC loop power supply).

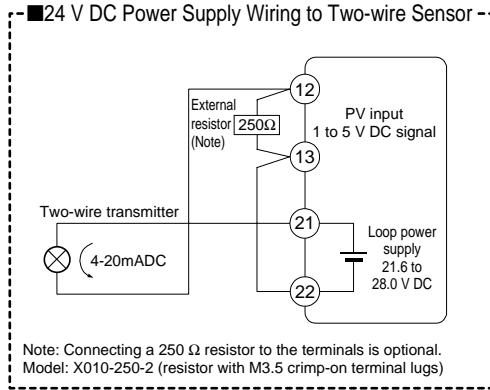

Retransmission Output

Either PV or target set point is output. Either this or the 15V DC loop power supply is available.

- Number of output point: 1
- Output signal: 4 to 20mA DC
- On-load resistance: 600 Ω or less
- Output accuracy: ±0.3% of the span
- Performance in the standard operating conditions (at 23±2°C, 55±10% RH, and 50/60 Hz power frequency)

- 15V DC loop power supply:
 - Power supply voltage 14.5 to 18.0V DC; maximum supply current approximately 21mA. (Safety circuit against short-circuiting in the field)

Contact Input

- Usage: Resets the displayed maximum and minimum process variables.
- Number of inputs: 1 point
- Input type: Non-voltage contact input or transistor open collector input
- Input contact capacity: 12V DC, 10mA or more (for non-voltage contact input)
- On/off determination:
 - For non-voltage contact input,
 - ON = contact resistance of 1kΩ or less,
 - OFF = contact resistance of 20kΩ or more.
 - For transistor contact input,
 - ON = 2V or less,
 - OFF = leak current of 100μA or less.
- Minimum retention time for status detection: about 1 s.

Contact Outputs

- Usage: Alarm output, FAIL output
- Number of relay contact outputs: 4 points (The alarm -4 is optional)
- Alarm -1 to -3 relay contact rating: 240V AC 1A, or 30V DC 1 A, make contact
- Alarm -4 relay contact rating: 250V AC 3 A, or 30V DC 3 A (load resistance)
- Output signal: 3 terminals (NC, NO, Common), transfer contact

● Display Unit Specifications

- Process variable display unit:
 - 4-digit 7-segment red LED, each digit 20 mm in height
- Parameter display:
 - 4-digit 7-segment red LED, each digit 9.3 mm in height
- Status indicating lamps: LEDs

● Conformance to Safety and EMC standards

- Safety: Compliant with IEC/EN61010-1: 2001, approved by CSA1010, approved by UL508.
 - Installation category : CAT. II (IEC/EN61010, CSA1010)
 - Pollution degree : 2 (IEC/EN61010, CSA1010)
 - Measurement category : I (CAT. I : IEC/EN61010)
 - Rated measurement input voltage : 10V DC max.(across terminals), 300V AC max.(across ground)
 - Rated transient overvoltage : 1500V (Note)
 - Note : It is a value on the safety standard which is assumed by IEC/EN61010-1 in measurement category I, and is not the value which guarantees an apparatus performance.

EMC standards: Complies with EN61326

During test, the controller continues to operate with the measurement accuracy within ±20% of the range.

● Construction/Installation/Wiring

- Structure: Dust-proof and Drip-proof front panel conforming to IP55.
- Body construction: ABS resin and polycarbonate
- Case color: Black
- Weight: Approximately 1 kg or less
- Dimensions: 96W × 48H × 100D (from the front panel) (mm)
- Mounting: Direct panel mounting; mounting bracket, one each for right and left mounting.
- Panel cutout dimensions: 92^{+0.8} (W) × 45^{+0.6} (H) mm
- Mounting attitude: Up to 30 degrees above the horizontal. No downward tilting allowed.
- Wiring: M3.5 screw terminal (signals, power supply/ground)

● Power supply / Isolation

- Power supply: Voltage rating at 100 to 240V AC (±10%), 50/60 Hz
- Power consumption: MAX. 20VA (MAX. 8.0W)
- Memory backup: Non-volatile memory (Service life approx. 1000,000 times of writings)
- Withstanding voltage:
 - Between primary terminal and secondary terminal: 1500V AC for 1 min.
 - Between primary terminal and ground terminal: 1500V AC for 1 min.
 - Between ground terminal and secondary terminal: 1500V AC for 1 min.
 - Between two secondary terminal: 500V AC for 1min

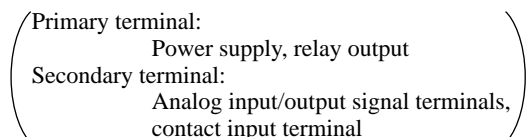

- Isolation resistance: Between power supply terminal and ground terminal, 500V DC 20MΩ or more
- Ground: Class 3 grounding (grounding resistance of 100Ω or less)

Isolation specifications

Measured input terminal:

Isolated from other input/output terminals.
Not isolated from the internal circuit.

24V DC loop power supply terminals for sensor:

Isolated from other input/output terminals
and internal circuit.

Retransmission output terminal:

Isolated from other input/output terminals
and internal circuit.

Contact input terminal:

Not isolated from communication terminals.
Isolated from other input/output terminals
and internal circuit.

Relay contact output terminal:

Isolated from other input/output terminals
and internal circuit.

RS-485 communication terminals:

Not isolated from contact input terminals.
Isolated from other I/O terminals and
internal circuit.

Power supply terminal:

Isolated from other input/output terminals,
and internal circuit.

Ground terminal:

Isolated from other input/output terminals,
and internal circuit.

● Environmental conditions

Normal operating conditions:

Ambient temperature: 0 to 50°C

0 to 40°C when using 24V DC loop power
supply for sensor

Ambient temperature change limit: 10°C /h or less

Ambient humidity: 20 to 90% RH (non-condensing)

Magnetic field: 400 A/m or less

Continuous vibration (5 to 14 Hz):

Amplitude of 1.2 mm or less

Continuous vibration (14 to 150 Hz):

4.9 m/s² or less

Short-period vibration: 14.7 m/s², 15 s. or less

Shock: 147 m/s² or less, 11 ms.

Installation altitude:

2,000 m above sea level maximum

Warm-up time: 30minutes or more

Transit/storage conditions

Temperature: -25° to 70°C

Temperature change limit: 20°C /h or less

Humidity: 5 to 95% RH (non-condensing)

Effects on operating conditions

Effect of ambient temperature:

For voltage/TC input, within $\pm 1\mu\text{V}/^\circ\text{C}$ and
 $\pm 0.01\%$ of F.S./°C, whichever is greater.

For RTD input, within $\pm 0.05\text{ }^\circ\text{C}/^\circ\text{C}$
(ambient temperature)

For analog output, $\pm 0.05\%$ of F.S./°C or less

Effect on power supply fluctuation (within rated voltage
range):

For analog input, within $\pm 1\text{ }\mu\text{V}/10\text{V}$ and
 $\pm 0.01\%$ of F.S./10V, whichever is greater.

For analog output, within $\pm 0.05\%$ of F.S./
10V

Standard Type, Terminal Arrangements

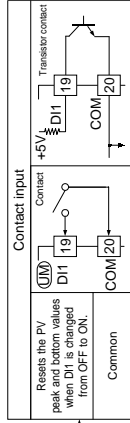
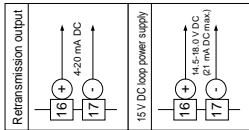
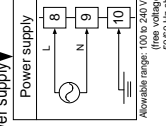
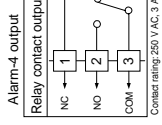
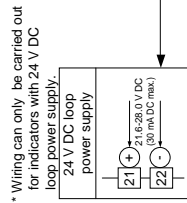
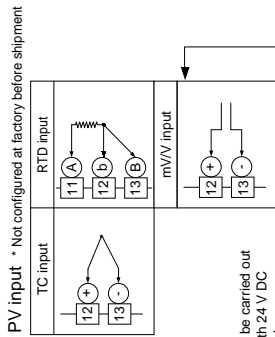
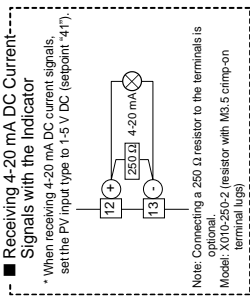

* Wiring can only be carried out for indicators with communication functions.
Maximum baud rate: 9600 bps

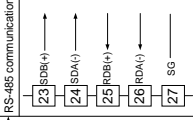

CAUTION
Before carrying out wiring, turn off the power to the controller and check that cables to be connected are not alive with a tester or the like. Consider there is a possibility of electric shock.

* Wiring can only be carried out for indicators with 24 V DC loop power supply.

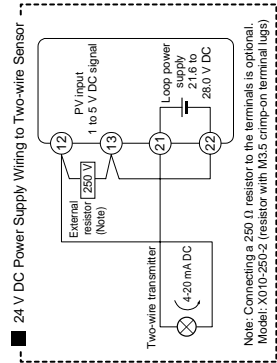
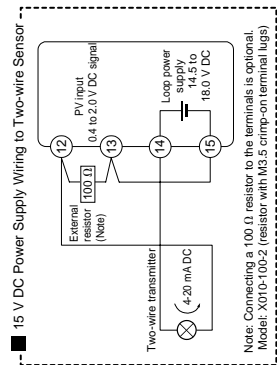

External Dimensions and Panel Cutout Dimensions

Unit: mm

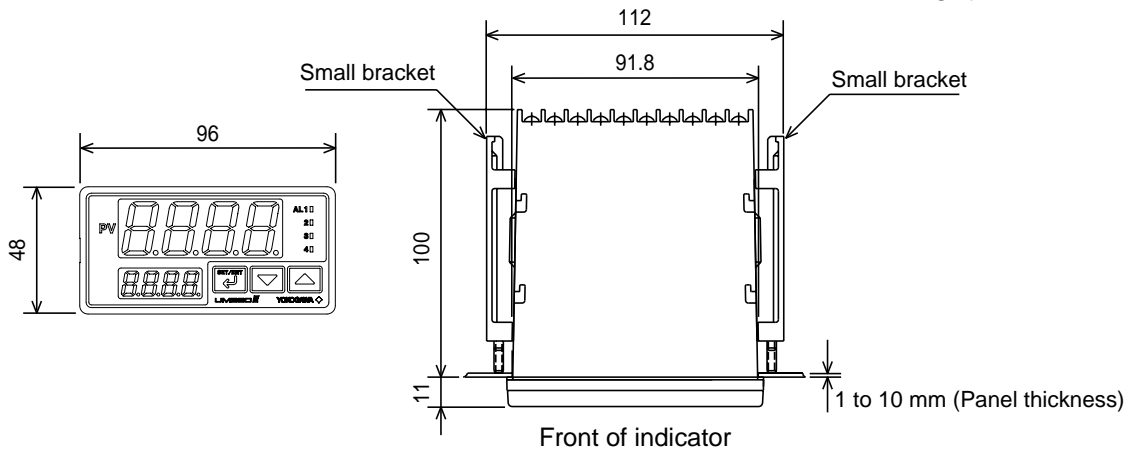

General installation

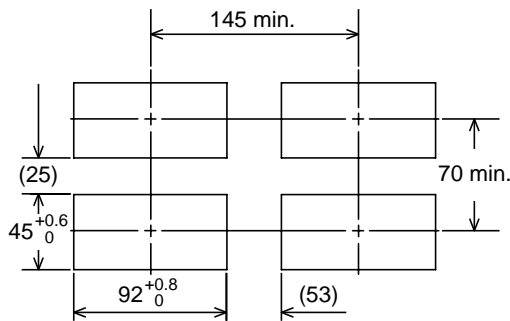

Model and Suffix Codes

Model	Suffix Code	Description
UM330		Digital indicator with alarms (provided with retransmission output and 15 V DC loop power supply as standard)
Type	-0	Standard type with three alarms
	-3	Standard type with three alarms (with 24 V DC loop power supply)
Optional functions	0	None
	1	With communication and additional alarm-4
	2	With additional alarm-4

Standard accessories: Brackets (mounting hardware), unit label, and User's Manuals,

Items to be Specified When Ordering

Model and suffix codes, necessary/unnecessary of User's Manual or QIC.

